

100 VMQ 55/60 	101 N.D. 	102 VMQ 60 	103 VMQ 60 	104 VMQ 55/60 	105 VMQ 50 	106 VMQ 60 N.D.
107 VMQ 70 	108 VMQ 70 	109 N.D. N.D.	110 N.D. N.D.	111 VMQ 60 	112 VMQ 50 	113 VMQ 50 N.D.
114 VMQ 60/70 	115 VMQ 60 	116 VMQ 60 	117 VMQ 60 	118 VMQ 60 	119 VMQ 70 	120 VMQ 60
121 VMQ 40 	122 VMQ 70 	123 VMQ 60 	124 VMQ 60 	125 VMQ 70 	126 VMQ 60 	127 VMQ 60
128 VMQ 50/60 - EPDM 60 	129 VMQ 50/60 	130 VMQ 60 	131 VMQ 60 	132 VMQ 50/60 	133 VMQ 60 	134 VMQ 60

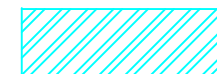

VMQ

VMQ
ESPANSO

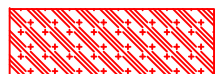
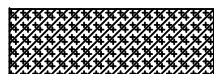







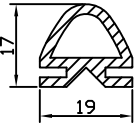
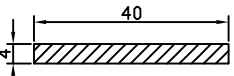
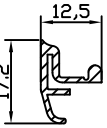
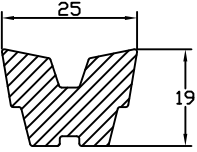
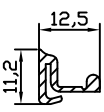
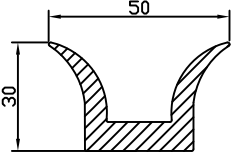
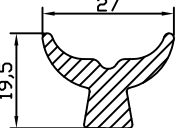

EPDM

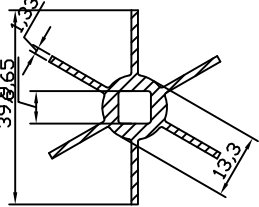
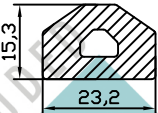
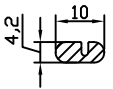
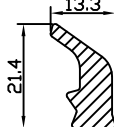
EPDM
ESPANSO

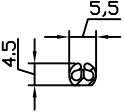
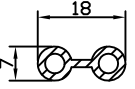
NBR

SBR

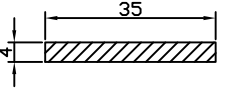
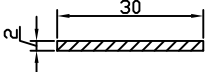
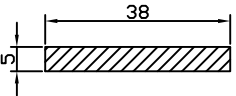
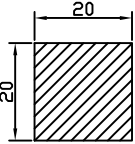
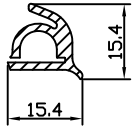
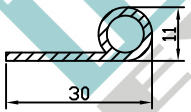
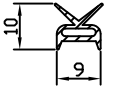
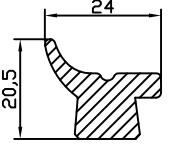
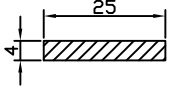
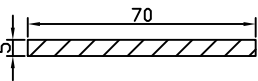
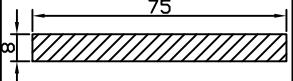
CR

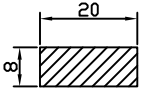
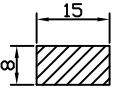
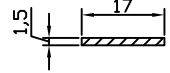
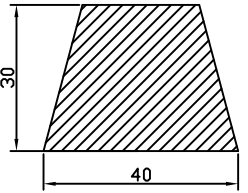
135 VMQ 50/60 	136 VMQ 40/60 	137 VMQ 70 	138 VMQ 40/70 	139 VMQ 60 	140 VMQ 50/60 	141 VMQ 55/65 
142 VMQ 60 	143 VMQ 50 	144 VMQ 70 N.D.	145 VMQ 60 	146 VMQ 55/60 	147 VMQ 75 	148 VMQ 60 
149 VMQ 60 	150 VMQ 60 	151 VMQ 70 	152 VMQ 70 	153 VMQ 60 	154 VMQ 50 	155 VMQ 60 
156 VMQ 60 	157 VMQ 70 	158 VMQ 60/70 	159 VMQ 60 	160 VMQ 60 	161 VMQ 60 	162 VMQ 50/60 
163 VMQ 60 	164 VMQ 55/60 	165 VMQ 50/60 	166 VMQ 60 	167 VMQ 50/60 	168 VMQ 70 	169 VMQ 50/60 

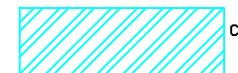
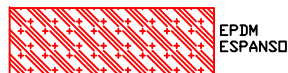
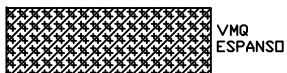
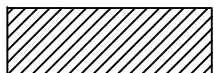



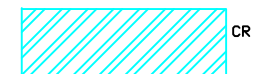
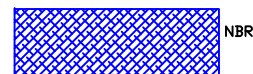
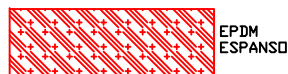
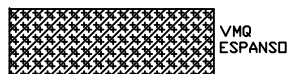



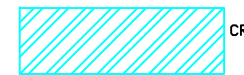
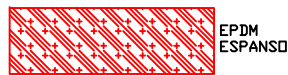
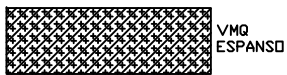
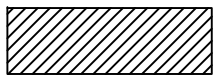

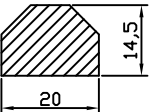
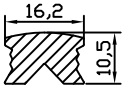
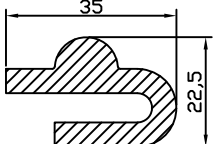

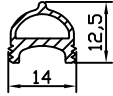
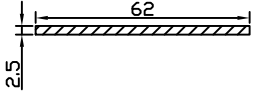
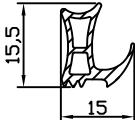
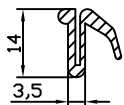
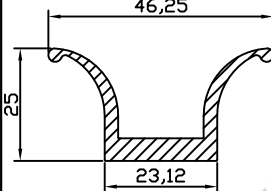
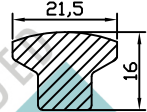
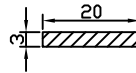
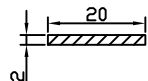
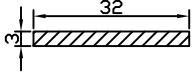
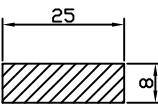

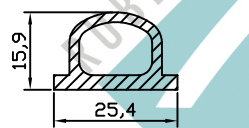
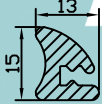
170 VMQ 60 N.D.	171 VMQ 60/65 	172 VMQ 50 	173 VMQ 50/60 	174 VMQ 50 N.D.	175 VMQ 75 	176 VMQ 60
177 VMQ 50/60 	178 VMQ 60 	179 VMQ 60 	180 VMQ 50 	181 VMQ 50 	182 VMQ 60 	183 VMQ 60/65
184 VMQ 60 	185 VMQ 50 	186 VMQ 60 	187 N.D.	188 N.D.	189 VMQ 60 	190 N.D.
191 N.D. 	192 VMQ 60 	193 VMQ 50 	194 N.D. 	195 VMQ 60 	196 VMQ 60 	197 VMQ 60
198 VMQ 60 - EPDM 50 	199 N.D. 	200 VMQ 60 	201 VMQ 60 	202 VMQ 60 	203 VMQ 50 	204 VMQ 50

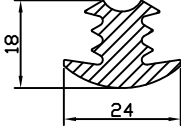

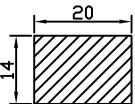
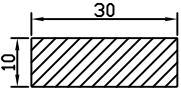
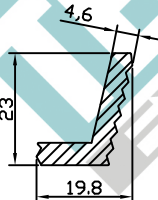
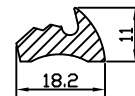
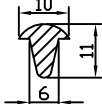
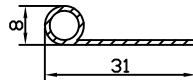
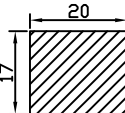
205 VMQ 60 	206 VMQ 60 	207 VMQ 60 	208 VMQ 60 	209 VMQ 50/70 	210 VMQ 60 	211 VMQ 50
212 VMQ 60 	213 VMQ 60 	214 VMQ 60 	215 VMQ 60 	216 VMQ 70 	217 VMQ 60 	218 VMQ 50
219 VMQ 60 	220 VMQ 70 	221 VMQ 60 	222 VMQ 60 	223 VMQ 50 	224 VMQ 70 	225 VMQ 60 - EPDM 70
226 EPDM 70 	227 VMQ 50 	228 VMQ 50 	229 VMQ 60 	230 N.D. 	231 VMQ 60 N.D.	232 VMQ 75
233 VMQ 60 	234 VMQ 60 	235 VMQ 75 	236 VMQ 75 	237 VMQ 80 	238 VMQ 60 	239 VMQ 55/65

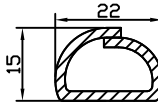
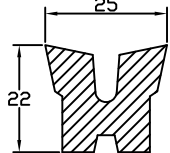

240 VMQ 40 	N.D.	242 VMQ 60 	243 VMQ 60 	244 VMQ 35/45 	245 VMQ 70 	246 N.D. 
247 VMQ 60 	248 VMQ 60 	249 VMQ 50/60 	250 VMQ 60 	251 VMQ 60 	252 VMQ 60 	253 VMQ 50 
254 VMQ 40/60 	255 VMQ 60 	256 VMQ 65 	257 VMQ 50 	258 VMQ 50/70 	259 VMQ 60 	260 VMQ 50 
261 VMQ 60 	262 VMQ 50 	263 VMQ 65 	264 VMQ 70 	265 VMQ 70 	266 VMQ 60 	267 VMQ 50 
268 VMQ 45 	269 VMQ 60 	270 VMQ 60 	271 VMQ 70 	272 VMQ 60 	N.D.	274 VMQ 55/70 

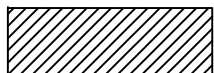

VMQ

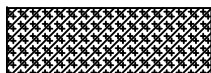

VMQ
ESPANSO



EPDM



EPDM
ESPANSO

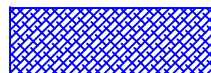

NBR





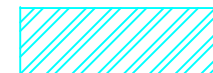



SBR

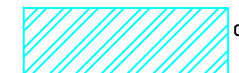
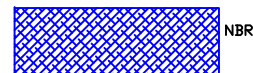
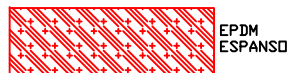
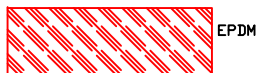
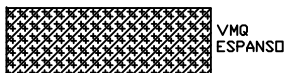

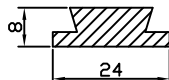
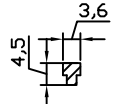
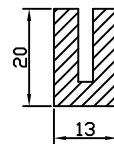
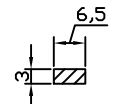
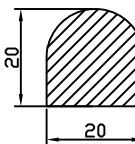
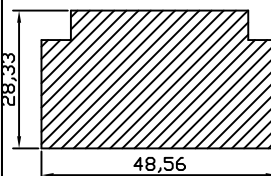
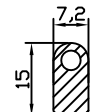
CR

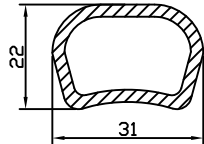
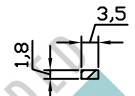
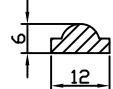
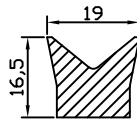
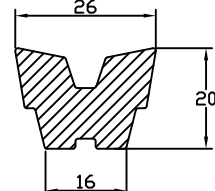
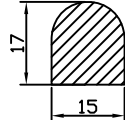
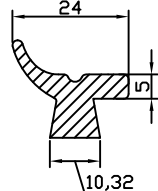
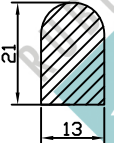
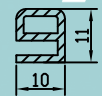
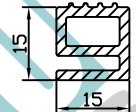
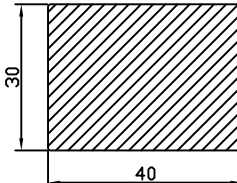
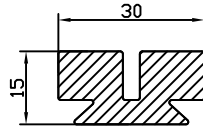
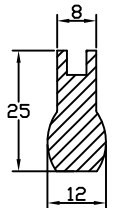
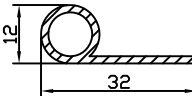
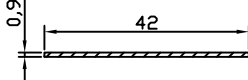
275 VMQ 40/55 	276 VMQ 60 	277 VMQ 60 	278 VMQ 60 	279 VMQ 60 	280 VMQ 60 	281 N.D.
282 VMQ 70 	283 VMQ 60 	284 VMQ 60 	285 VMQ 60 	286 VMQ 50 	287 VMQ 65/70 	288 VMQ 65/70
289 VMQ 70 	290 VMQ 60 	291 VMQ 60 	292 VMQ 60 	293 VMQ 35/60 	294 VMQ 70 	295 VMQ 60
296 VMQ 80 	297 VMQ 70 	298 VMQ 50/70 	299 VMQ 60 	300 VMQ 60 	301 VMQ 60 	302 VMQ 70
303 VMQ 60 	304 VMQ 60 	305 N.D. 	306 N.D. 	307 VMQ 60 	308 VMQ 70/80 	309 VMQ 75

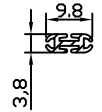
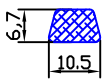

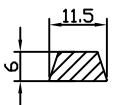
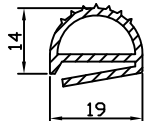
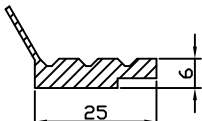
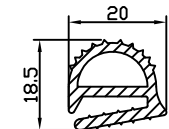
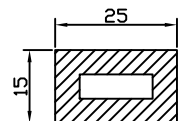
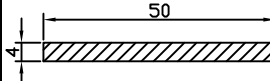
310 VMQ 60 	311 VMQ 70 	312 VMQ 65 	313 VMQ 50 	314 VMQ 45/50 	315 VMQ 45/50 	316 VMQ 60 
317 VMQ 60 	318 VMQ 60/70 	319 VMQ 50 	320 VMQ 55 	321 VMQ 70 	322 VMQ 60 	323 VMQ 50 
324 VMQ 60 	325 VMQ 60 	326 VMQ 35 	327 VMQ 60 	328 VMQ 60 	329 VMQ 60/70 	330 VMQ 40 
331 VMQ 60 	332 VMQ 60 	333 VMQ 70 	334 VMQ 50/60 	335 N.D. 	336 NBR 60 	337 EPDM 80 
338 VMQ 60 	339 VMQ 60/70 	340 VMQ 60 	341 VMQ 60 	342 VMQ 60 	343 VMQ 60 	344 VMQ 60 



VMQ

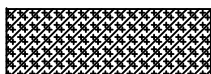

VMQ
ESPANSO



EPDM

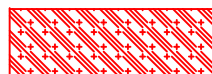

EPDM
ESPANSO

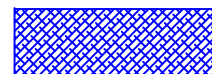





NBR

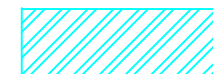

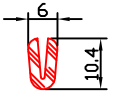

SBR

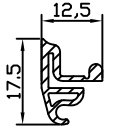
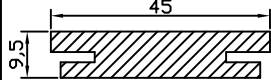
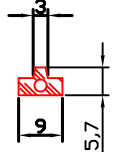
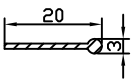
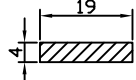
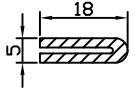

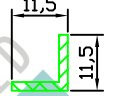
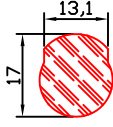
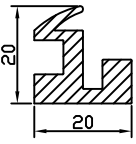
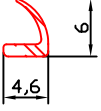
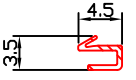
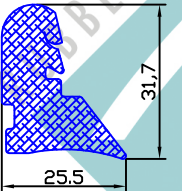
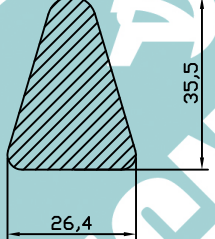
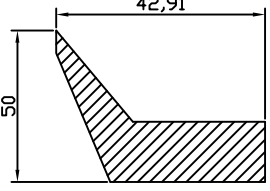
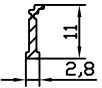
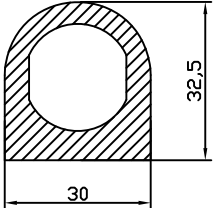
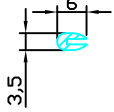
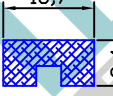
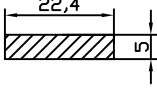
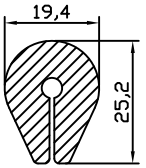
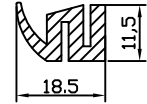
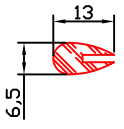
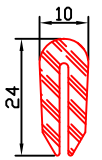
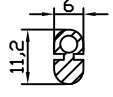
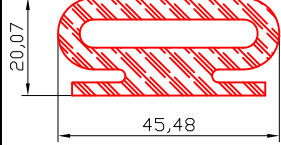
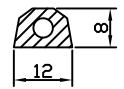
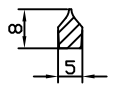

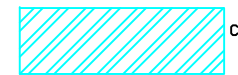
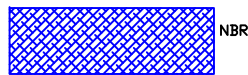
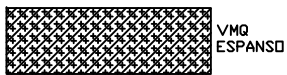
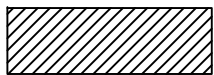

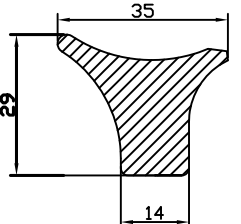
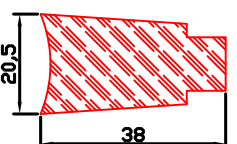
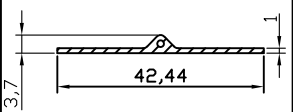
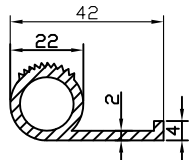
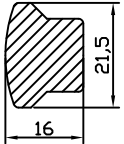
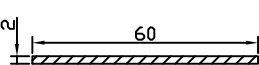
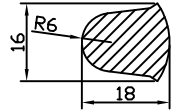
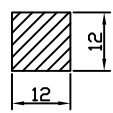
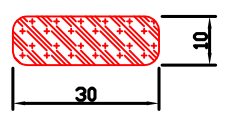
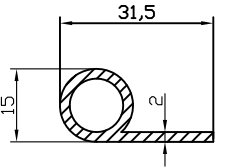
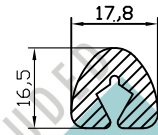
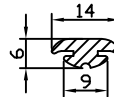
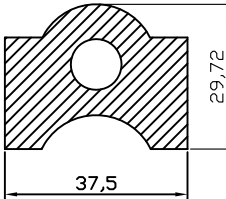
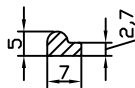
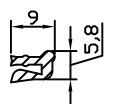
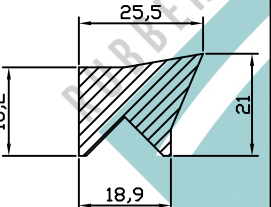

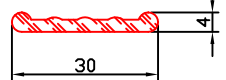
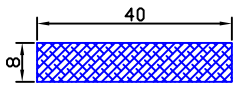
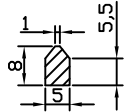
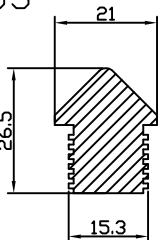
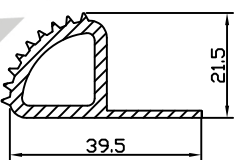
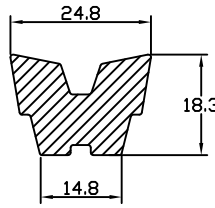
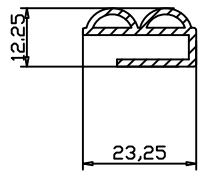
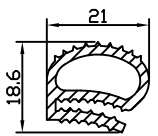
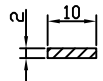
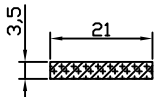
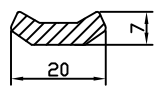
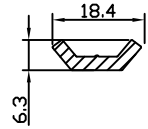
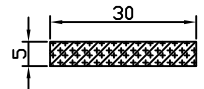

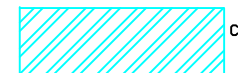
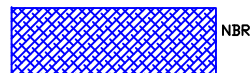
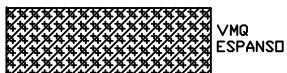
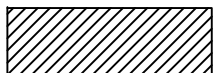

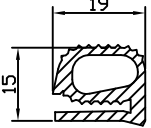
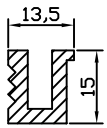

CR

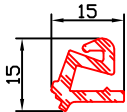
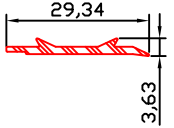
345 EPDM 70 	346 EPDM 60 	347 VMQ 60 	348 VMQ 60 - EPDM 75 	349 EPDM 45 - SBR 60 	350 VMQ 60 	351 VMQ 60 
352 EPDM 65 N.D.	353 VMQ 60 	354 VMQ 60/70 - EPDM 70 	355 SBR 70 	356 EPDM 70/80 	357 VMQ 60 	358 EPDM 70 N.D.
359 EPDM 70 	360 EPDM 70 	361 NBR 80 	362 VMQ 70 	363 N.D.	364 VMQ 60 	365 NBR 70/80 
366 N.D.	367 VMQ 70 	368 CR 70 	369 NBR 70 	370 VMQ 35 	371 VMQ 60 	372 VMQ 60 
373 EPDM 70 	374 EPDM 60 	375 N.D. N.D.	376 VMQ 35/60 	377 EPDM 70 	378 VMQ 60 	379 VMQ 60 

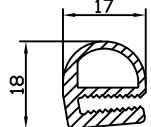
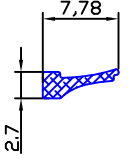



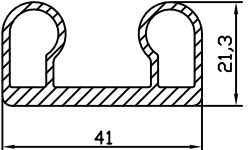
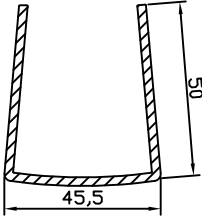
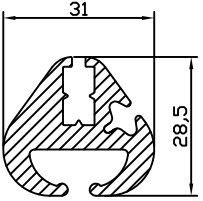

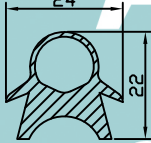
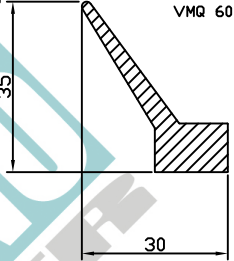
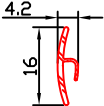
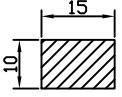
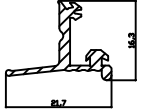
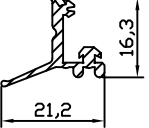
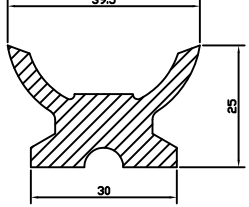
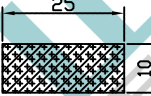
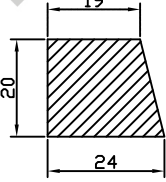
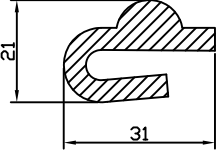
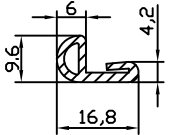
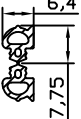
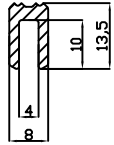
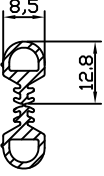
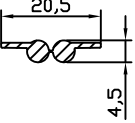
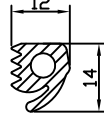
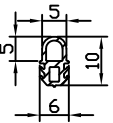

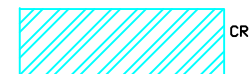
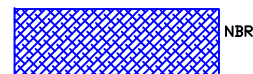
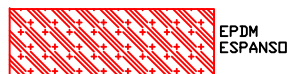
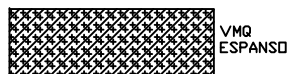

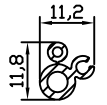
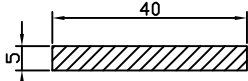
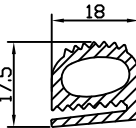
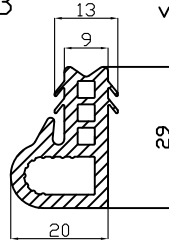
380 VMQ 65 	381 EPDM 70 	382 VMQ 65 	383 VMQ 60 	384 VMQ 60 	385 VMQ 70 	386 VMQ 70 
387 VMQ 60 	388 EPDM espanso 0,5 	389 VMQ 60 	390 VMQ 40 	391 N.D.	392 VMQ 60 	393 VMQ 70 
394 VMQ 75 	395 VMQ 60 	396 VMQ 60 	397 N.D.	398 N.D.	399 EPDM 70 	400 EPDM 70 
401 NBR 55 	402 VMQ 60 	403 VMQ 80 	404 N.D.	405 VMQ 60 	406 N.D. 	407 VMQ 50/60 
408 N.D.	409 VMQ 60 	410 VMQ 70 	411 VMQ espanso 0,6 	412 VMQ 50 	413 VMQ 50 	414 VMQ espanso 0,6 

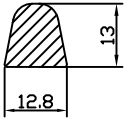
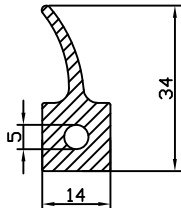
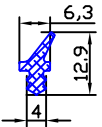
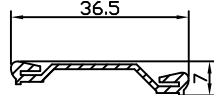
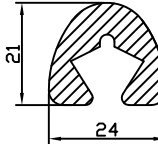
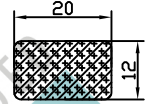
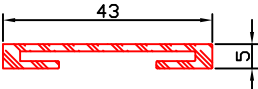

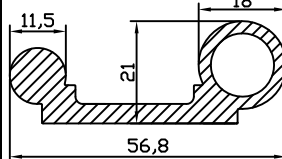
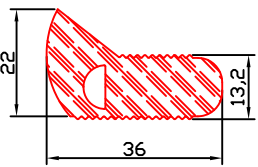
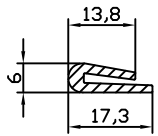
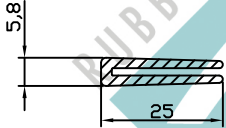
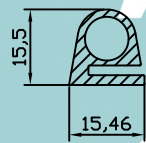
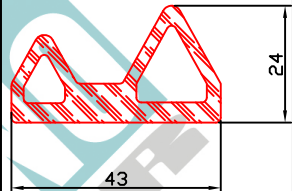
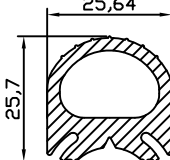
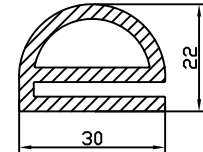
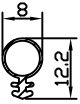
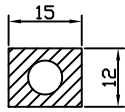
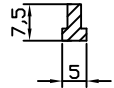
415 VMQ espanso 0,6 	416 VMQ 60 	417 VMQ 60 	418 VMQ 55/60 	419 VMQ 60 	420 EPDM 70 	421 EPDM 65 
422 VMQ 50 	423 VMQ 80 	424 NBR 80 	425 VMQ 70 	426 VMQ espanso 0,45 	427 VMQ espanso 0,45 	428 VMQ 60 
429 VMQ 70 	430 VMQ 60 	431 VMQ 60 	432 VMQ 50 	433 VMQ 60 	434 EPDM 70 	435 VMQ 50/60 
436 VMQ 50 	437 VMQ 50 	438 VMQ 50 	439 VMQ espanso 0,6 	440 VMQ 60 	441 VMQ 60 	442 N.D.
443 VMQ 60 	444 VMQ 50/55 	445 VMQ 50 	446 VMQ 50 	447 VMQ 30 	448 VMQ 50 	449 VMQ 60 

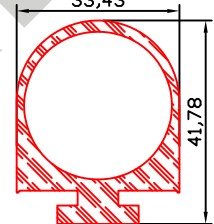
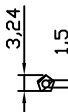
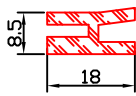
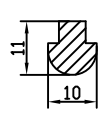
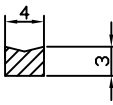
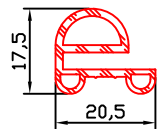

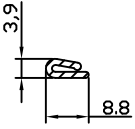
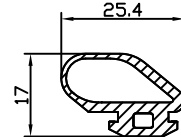
450 VMQ 70 	451 VMQ 60 	452 VMQ 60 	453 VMQ 50 	454 VMQ 60 	455 VMQ 60 	456 VMQ 70 
457 NBR 70 	458 VMQ 80 	459 VMQ 40 	460 VMQ espanso 0,5 	461 EPDM 70 	462 VMQ espanso 0,5 	463 VMQ 70 
464 EPDM 70 	465 VMQ 60 	466 VMQ 50 	467 VMQ 60 	468 EPDM 70 	469 VMQ 60 	470 VMQ 60 
471 VMQ 60 	472 VMQ 60 	473 VMQ 50 	474 EPDM espanso 0,45 	475 EPDM 50/70 	476 VMQ 35/50 	477 EPDM 60 
478 VMQ 50/60 	479 VMQ 50 	480 EPDM 70 	481 VMQ espanso 0,5 	482 EPDM 50 	483 VMQ 60 	484 VMQ 50 



VMQ

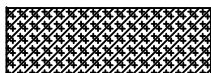

VMQ
ESPANSO



EPDM



EPDM
ESPANSO



NBR



SBR

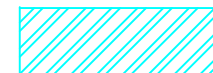

CR

<p>485 VMQ 50</p>	<p>486 VMQ 35</p>	<p>487 NBR 70</p>	<p>488 NBR 70</p>	<p>489 EPDM 70</p>	<p>490 VMQ 50</p>	<p>491 VMQ 60</p>
<p>492 VMQ 50</p>	<p>493 VMQ 60</p>	<p>494 VMQ 60</p>	<p>495 VMQ 60</p>	<p>496 VMQ 60</p>	<p>497 VMQ 60</p>	<p>498 VMQ 70</p>
<p>499 VMQ 60</p>	<p>500 VMQ 60</p>	<p>501 VMQ 60</p>	<p>502 VMQ 60</p>	<p>503 EPDM 60 - VMQ 50</p>	<p>504 VMQ 60</p>	<p>505 VMQ 50</p>
<p>506 VMQ 60</p>	<p>507 VMQ 60</p>	<p>508 VMQ 60</p>	<p>509 EPDM 60</p>	<p>510 VMQ 60</p>	<p>511 VMQ 60</p>	<p>512 EPDM 85</p>
<p>513 EPDM 70</p>	<p>514 NBR 70</p>	<p>515 VMQ 50</p>	<p>516 VMQ 50</p>	<p>517 VMQ espanso 0,6</p>	<p>518 VMQ espanso 0,6</p>	<p>519 VMQ 50</p>



VMQ

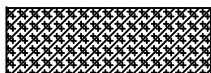

VMQ
ESPANSO



EPDM



EPDM
ESPANSO

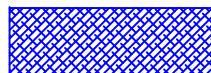

NBR



SBR

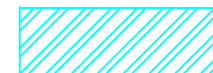

CR

520 N.D.	521 VMQ 60 	522 VMQ 60 	523 VMQ espanso 0,6 	524 VMQ 50 	525 EPDM 70 	526 EPDM 70
527 EPDM 70 	528 EPDM 70 	529 VMQ 50 	530 NBR 70 	531 VMQ 60 	532 VMQ 60 	533 N.D.
534 VMQ 50/70 	535 NBR 70 	536 VMQ 60 	537 EPDM 50 	538 EPDM 60/70 	539 VMQ 60 	540 EPDM 70
541 EPDM 70 	542 EPDM 50/70 	543 VMQ espanso 0,75 	544 EPDM 70 	545 VMQ 60 	546 VMQ 60 	547 VMQ 80
548 VMQ 40 	549 EPDM 70 	550 EPDM 70 	551 EPDM 70 	552 EPDM 70 	553 VMQ 40 	554 EPDM 70



VMQ

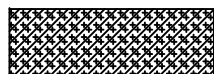

VMQ
ESPANSO



EPDM



EPDM
ESPANSO

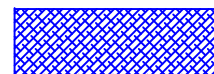



NBR

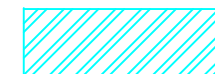

SBR



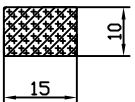
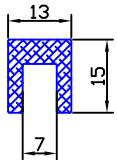
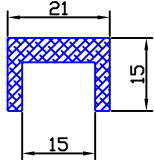
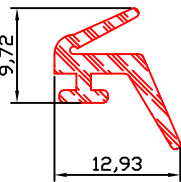
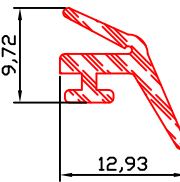
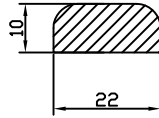
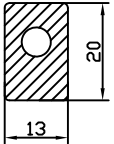
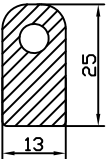
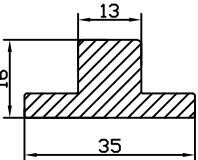
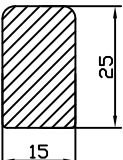
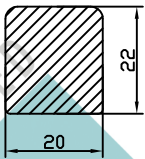
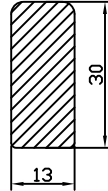
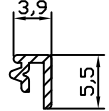
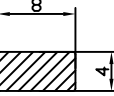
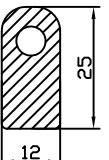
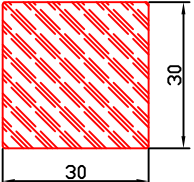
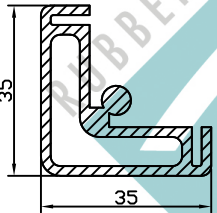
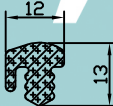
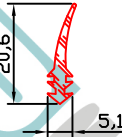
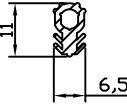
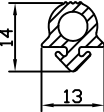
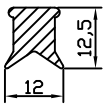
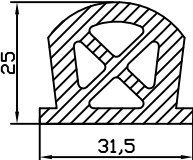
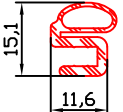

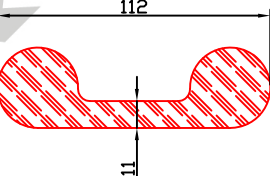
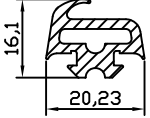
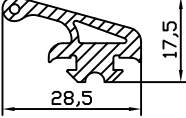
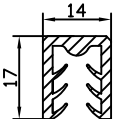
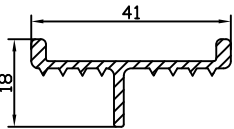
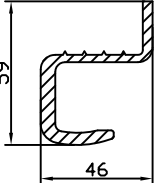
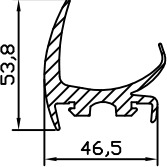
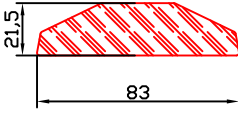
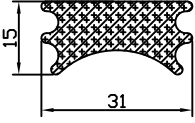
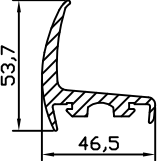

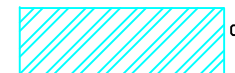
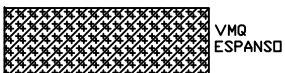



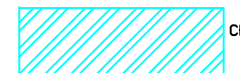
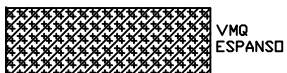
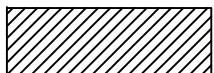

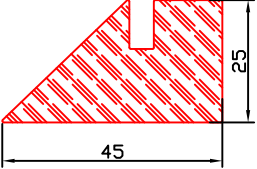
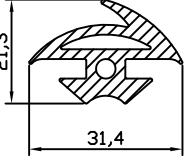
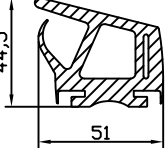
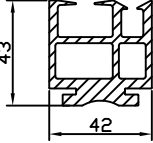
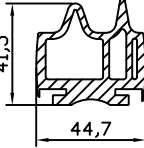
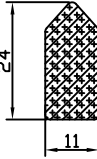
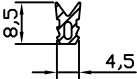
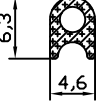



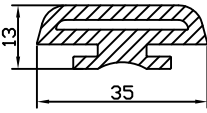
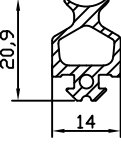
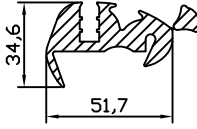
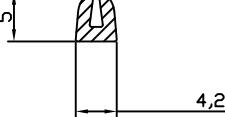
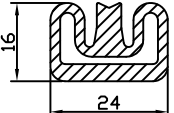

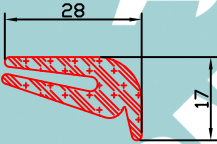
CR

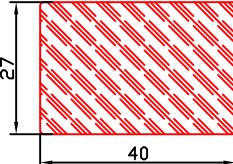
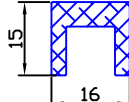
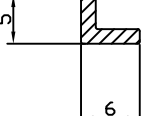
555 VMQ espanso 0,6 	556 NBR 70 	557 NBR 70 	558 EPDM 65 	559 EPDM 65 	560 VMQ 50 	561 VMQ 60 
562 VMQ 60 	563 VMQ 60 	564 VMQ 60 	565 VMQ 60 	566 VMQ 60 	567 VMQ 60 	568 VMQ 60 
569 VMQ 60 	570 EPDM 65 	571 VMQ 70 	572 VMQ espanso 0,6 	573 EPDM 70 	574 VMQ 60 	575 VMQ 60 
576 VMQ 60 	577 VMQ 50 	578 EPDM 60 	579 VMQ espanso 0,45 	580 NBR 70 	581 VMQ 70 	582 VMQ 70 
583 VMQ 70 	584 VMQ 70 	585 VMQ 70 	586 VMQ 70 	587 EPDM 70 	588 VMQ espanso 0,6 	589 VMQ 70 

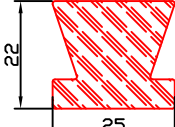
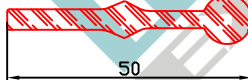
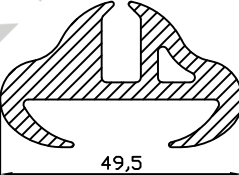

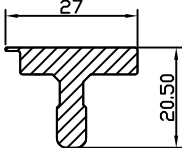
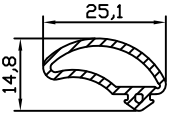
<p>590 EPDM 65</p>	<p>591 VMQ 60</p>	<p>592 VMQ espanso 0,5</p>	<p>593 EPDM 60</p>	<p>594 VMQ 60</p>	<p>595 NBR 60</p>	<p>596 VMQ 60</p>
<p>597 NBR 85</p>	<p>598 NBR 60</p>	<p>599 N.D.</p>	<p>600 VMQ 70</p>	<p>601 VMQ 60</p>	<p>602 NBR 70</p>	<p>603 VMQ 60</p>
<p>604 EPDM 70</p>	<p>605 EPDM 65</p>	<p>606 VMQ 60</p>	<p>607 VMQ 60</p>	<p>608 EPDM 60</p>	<p>609 EPDM 50</p>	<p>610 EPDM 65</p>
<p>611 VMQ 60</p>	<p>612 VMQ 40</p>	<p>613 VMQ 60</p>	<p>614 EPDM 70</p>	<p>615 EPDM 60</p>	<p>616 EPDM 60</p>	<p>617 VMQ 60</p>
<p>618 EPDM 50</p>	<p>619 VMQ 60</p>	<p>620 NBR 70</p>	<p>621 EPDM 60</p>	<p>622 VMQ 60</p>	<p>623 VMQ 60</p>	<p>624 EPDM 70</p>

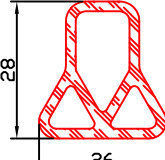

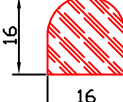
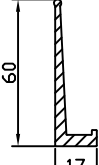
625 EPDM 70 	626 VMQ 70 	627 VMQ 70 	628 VMQ 70 	629 VMQ 70 	630 VMQ espanso 0,6 	631 VMQ 50 
632 VMQ espanso 0,5 	633 VMQ espanso 0,5 	634 NBR 70 	635 EPDM 60 	636 VMQ 70 	637 VMQ 70 	638 VMQ 70 
639 VMQ 50 	640 VMQ 70 	641 EPDM 50 	642 EPDM espanso 0,6 	643 EPDM 70 	644 EPDM 70 	645 NBR 70 
646 VMQ 60 	647 EPDM 60 	648 EPDM 70 	649 EPDM 70 	650 VMQ 70 	651 VMQ 70 	652 VMQ 50 
653 VMQ 50 	654 VMQ espanso 0,5 	655 VMQ 70 	656 EPDM 60 	657 EPDM 70 	658 EPDM 60 	659 VMQ 60 

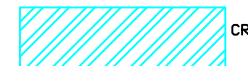
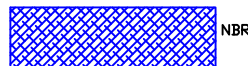
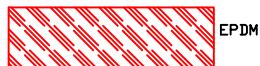

660 VMQ espanso 0,6 	661 VMQ espanso 0,6 	662 VMQ 40 	663 VMQ 60 	664 EPDM 70 	665 EPDM 70 	666 EPDM 60
667 VMQ espanso 0,6 	668 VMQ 50 	669 VMQ 60 	670 VMQ espanso 0,6 	671 VMQ espanso 0,7 	672 EPDM 70 	673 EPDM 70
674 EPDM 70 	675 EPDM 70 	676 VMQ 60 	677 VMQ 60 	678 VMQ 70 	679 EPDM espanso 0,6 	680 VMQ 50
681 EPDM 80 	682 EPDM 80 	683 N.D.	684 EPDM 60 	685 EPDM 70 - VMQ 70 	686 EPDM 70 - VMQ 70 	687 EPDM 70
688 EPDM 60 	689 EPDM 60 	690 EPDM espanso 0,6 	691 VMQ 60 	692 VMQ 50/55 	693 VMQ ESPANSO 	694 EPDM NERO SH.70

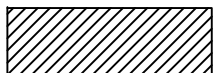

VMQ

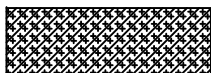

VMQ
ESPANSO



EPDM



EPDM
ESPANSO



NBR



SBR

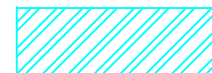

CR

<p>695 EPDM NERO SH. 70</p>	<p>696 EPDM 70 NERO</p>	<p>697 EPDM 70 BIANCO</p>	<p>698 EPDM GRIGIO SH.60</p>	<p>699 VMQ ESPANSO</p>	<p>700 VMQ ANTILACERAZIONE SH.70</p>	<p>701 VMQ TRASPARENTE SH.60</p>
<p>702 EPDM GRIGIO SH.60</p>	<p>703 N.D.</p>	<p>704 EPDM NERO SH.60</p>	<p>705 VMQ THERMIC NERO SH.80</p>	<p>706 EPDM ESPANSO NERO DS.0,5</p>	<p>707 VMQ ROSSO SH.60</p>	<p>708 NBR NERO SH.70</p>
<p>709 VMQ ROSSO SH.60</p>	<p>710 EPDM ESPANSO NERO DS.0,5</p>	<p>711 EPDM NERO SH.70</p>	<p>712 EPDM GRIGIO CHIARO SH.70</p>	<p>713 VMQ SH.70 GRIGIO (RH.MF 8270 E CR)</p>	<p>714 VMQ SH.70 GRIGIO (RH.MF 8270 E CR)</p>	<p>715 VMQ GRIGIO SH.60</p>
<p>716 EPDM NERO SH.75</p>	<p>717 EPDM NERO SH.75</p>	<p>718 N.D.</p>	<p>719 EPDM SH.70 NERO</p>	<p>720 VMQ SH.45</p>	<p>721 EPDM SH.75</p>	<p>722 EPDM SH.75</p>
<p>723 VMQ SH.60</p>	<p>724 NBR SH.80</p>	<p>725 VMQ SH.50</p>	<p>726 VMQ SH.50</p>	<p>727 VMQ SH.60</p>	<p>728 VMQ SH.60</p>	<p>729 EPDM NERO SH.80</p>

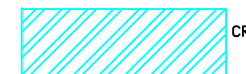
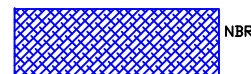
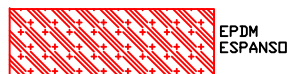
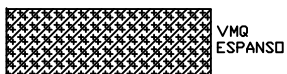

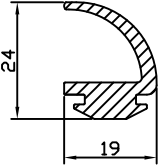
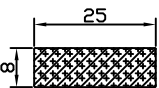
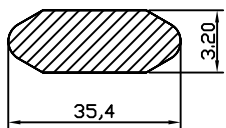
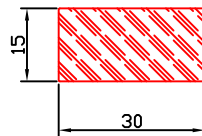
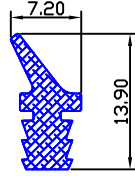
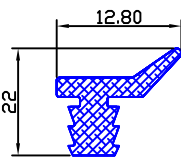
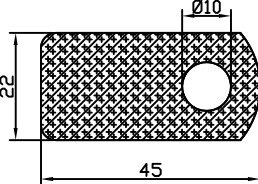
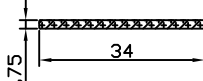
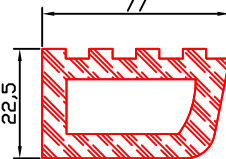
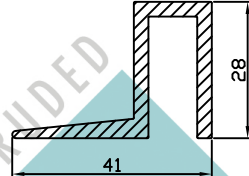
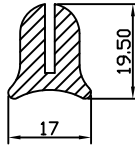
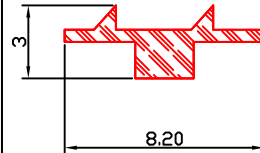
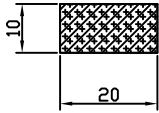
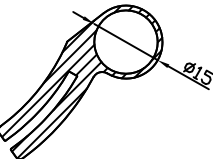
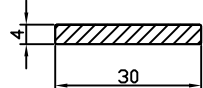
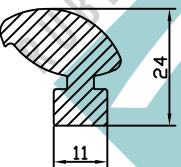
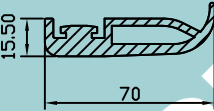
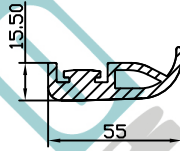
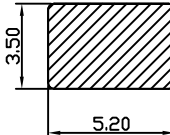
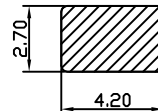
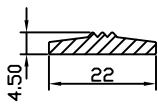
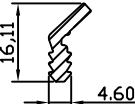
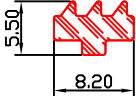
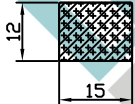
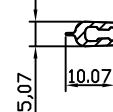
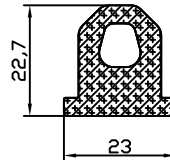
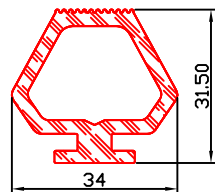
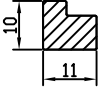
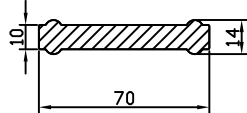
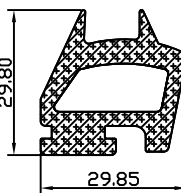
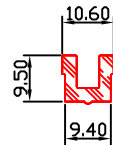
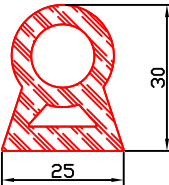
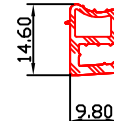
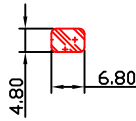
730 N.D.	731 VMQ BIANCO SH.60 	732 VMQ ESPANSO DS.0,6 	733 VMQ SH.35 	734 EPDM BIANCO SH.65 	735 NBR NERO SH.65 	736 NBR NERO SH.65 
737 VMQ ESPANSO BIANCO DS. 0,6 	738 VMQ ESP.D NERO DS. 0,6 	739 EPDM NERO SH.75 	740 VMQ ROSSO SH.60 	741 VMQ TRASP. SH.50 	742 EPDM NERO SH.60 	743 VMQ ESP. BIANCO D. 0,6 
744 VMQ VAPOR SH.60 	745 VMQ SH.60 	746 NBR SH.70 	747 VMQ BIANCO SHA.70 	748 VMQ BIANCO SHA.70 	749 VMQ SH.60 	750 VMQ SH.60 
751 VMQ SH.65 	752 NBR NERO SH.70 	753 EPDM NERO SH.50 	754 VMQ ESP. DS.0,7 	755 VMQ NERO SH.60 	756 VMQ ESPAN. DS.0,6 	757 EPDM NERO SH.70 
758 VMQ TRASP. SH.70 	759 VMQ ROSSO SH.60 	760 VMQ ESPAN. DS.0,6 	761 EPDM NERO SH.70 	762 EPDM NERO SH.70 	763 EPDM NERO SH.60 	764 EPDM ESP. DS.0,50 



VMQ

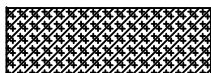

VMQ
ESPANSO



EPDM



EPDM
ESPANSO

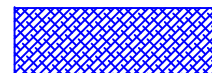







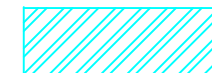

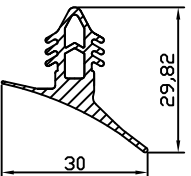
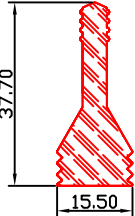
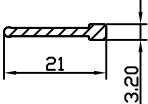
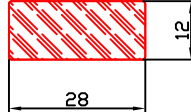

NBR

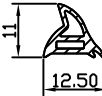
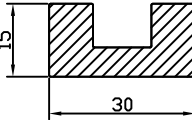
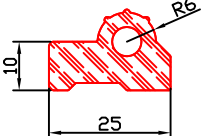
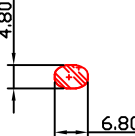
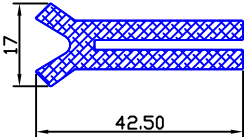
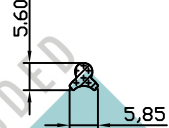
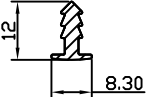
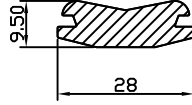
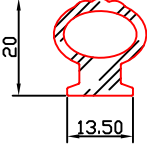
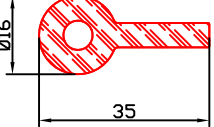
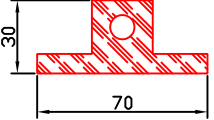

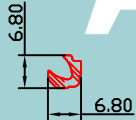
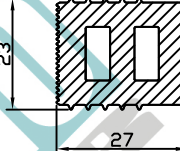
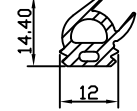
SBR

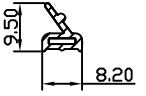
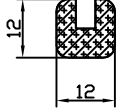
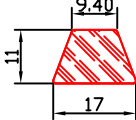
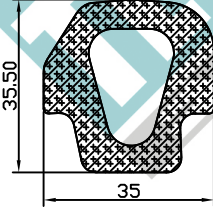
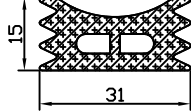
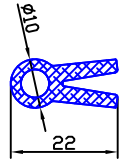

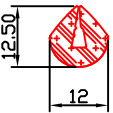
CR

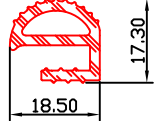
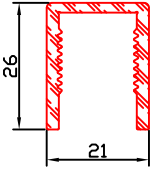
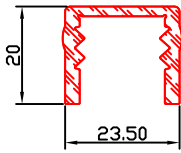
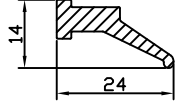
765 VMQ GRIGIO SH.70 	766 EPDM NERO SH.70 	767 VMQ AUTOE. GR. SH.70 	768 EPDM NERO SH.50 	769 EPDM NERO SH.50 	770 VMQ NERO SH.60 	771 VMQ TRASP. SH.60 
772 EPDM NERO SH.50 	773 EPDM ESP. 0,5 	774 NBR NERO SH.70 	775 VMQ ESP. DS.0,6 	776 VMQ BIANCO SH.70 	777 VMQ ROSSO SH.70 	778 EPDM NERO SH.75 
779 EPDM NERO SH.70 	780 EPDM NERO SH.70 	781 VMQ NERO SH.60 	782 EPDM SH.70 	783 VMQ TRASP. SH.60 	784 VMQ NERO SH.70 	785 VMQ NERO SH.60 
786 VMQ NERO SH.60 	787 VMQ ESP. DS.0,6 	788 EPDM SH.70 	789 VMQ ESP. DS.0,6 	790 VMQ ESP. DS.0,6 	791 NBR SH.70 	792 N.D.
793 VMQ TRASP. SH.50 	794 EPDM NERO SH.70 	795 EPDM NERO SH.80 	796 EPDM BIANCO SH.70 	797 EPDM SH.60 	798 EPDM SH.60 	799 VMQ SH.70 



VMQ

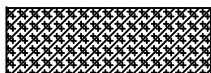

VMQ
ESPANSO



EPDM



EPDM
ESPANSO

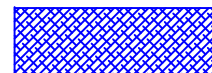



NBR

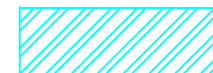

SBR

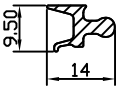
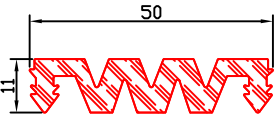
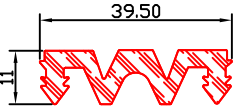
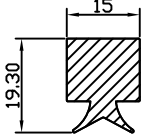
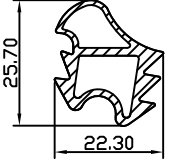
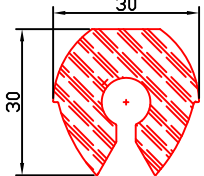
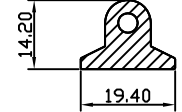
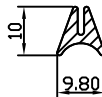
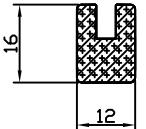
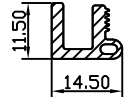
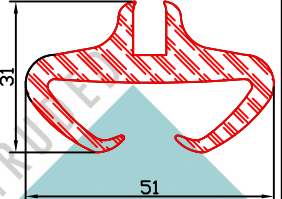
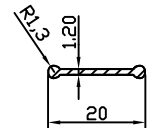
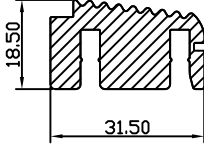
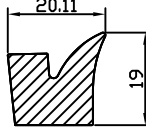

CR

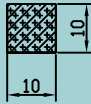
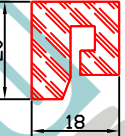
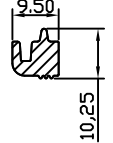
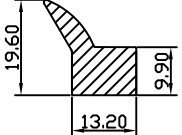
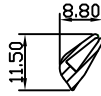
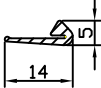
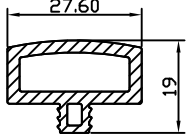
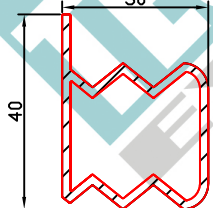
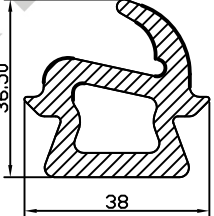
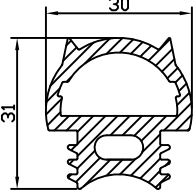
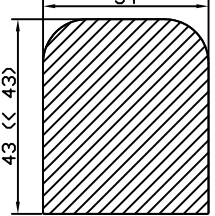
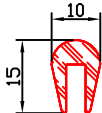
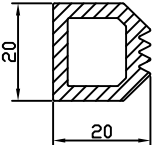
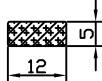
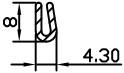
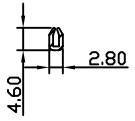
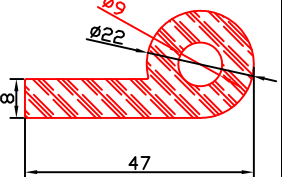
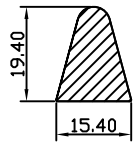
800 VMQ SH.70 	801 EPDM NERO SH.70 	802 EPDM NERO SH.70 	803 VMQ NERO SH.60 	804 VMQ GRIGIO SH.60 	805 EPDM NERO SH.70 	806 VMQ TRASP. SH.70 
807 VMQ NERO SH.40 	808 VMQ ESP. DS.0,6 	809 VMQ NERO SH.60 	810 EPDM NERO SH.60 	811 N.D.	812 VMQ MARR. SH.75 	813 VMQ NERO SH.60 
814 VMQ ROSSO SH.60 	815 EPDM ESP. NERO DS. 0,6 	816 SIL. ESP. B.CO DS.0,6 	817 SIL. ESP. B.CO DS.0,6 	818 EPDM NERO SH.60 	819 VMQ NERO SH.55 	820 VMQ ROSSO SH.70 
821 VMQ NEUTRO SH.40 	822 VMQ NEUTRO SH.40 	823 VMQ NERO SH.50 	824 EPDM NERO SH.60 	825 VMQ BIANCO SH.70 	826 VMQ NERO SH.60 	827 VMQ ROSSO SH.50 
828 EPDM NERO SH.50 	829 VMQ ROSSO SH.60 	830 VMQ ESP. DS.0,5 	831 SILIC. RAL 7042 SH.70 	832 SILIC. RAL 7042 SH.70 	833 EPDM NERO SH.60 	834 VMQ ROSSO SH.60 

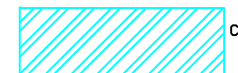
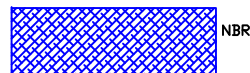
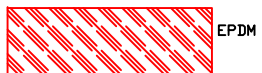
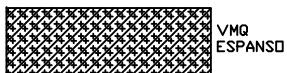

835 EPDM NERO SH.70 	836 EPDM NERO SH.80 	837 EPDM NERO SH.60 	838 VMQ BIANCO SH.60 	839 VMQ BIANCO SH.60 	840 VMQ TRASP. SH.70 	841 EPDM NERO SH.60
842 VMQ ESP. DS.0.6 	843 VMQ THT SH.60 	844 VMQ THT SH.60 	845 VMQ ROSSO SH.60 	846 VMQ BIANCO SH.60 	847 EPDM NERO SH.60 	848 VMQ BIANCO SH.60
849 EPDM NERO SH.80 	850 EPDM NERO SH.80 	851 N.D. 	852 EPDM NERO SH.70 	853 VMQ ESP. B.CO DS.0.5 	854 VMQ SH.70 	855 EPDM NERO SH.60
856 VMQ B.CO ESP. DS.0.4 	857 VMQ ROSSO SH.45 	858 EPDM NERO SH.80 	859 VMQ SH.60 	860 VMQ SH.60 	861 VMQ ESP. DS.0.45 	862 EPDM NERO SH.60
863 VMQ NERO SH.50 	864 VMQ GRIGIO SH.80 	865 VMQ NERO SH.50 	866 N.D. 	867 VMQ GR. SH.50 	868 EPDM NERO SH.85 	869 EPDM NERO SH.70

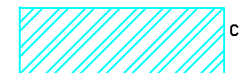
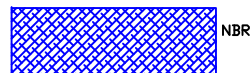
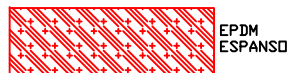
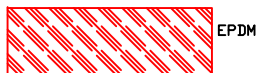
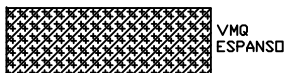

870 N.D.	871 VMQ TRASP. SH.60 	872 EPDM NERO SH.70 	873 VMQ GRIGIO SH.60 	874 EPDM NERO SH.70 	875 EPDM NERO SH.50 	876 EPDM NERO SH.50
877 EPDM NERO SH.50 	878 VMQ GRIGIO SH.70 	879 VMQ BIANCO SH.80 	880 VMQ NERO SH.60 	881 VMQ NERO SH.60 	882 VMQ NERO SH.60 	883 N.D.
884 VMQ TRASP. SH.60 	885 EPDM NERO SH.85 	886 EPDM NERO SH.65 	887 VMQ ESP. DS.0,7 	888 VMQ GRIGIO SH.70 	889 VMQ NERO SH.60 	890 VMQ NERO SH.60
891 NBR NERO SH.80 	892 VMQ B.CD SH.60 	893 VMQ TRASP. SH.60 	894 VMQ GR. SH.60 	895 VMQ NERO SH.60 	896 VMQ TRASP. SH.40 	897 EPDM NERO SH.65
898 EPDM NERO SH.70 	899 EPDM NERO SH.75 	900 EPDM NERO SH.80 	901 VMQ GRIGIO SH.60 	902 VMQ ROSSO SH.60 	903 EPDM GRIGIO SH.75 	904 VMQ GR. SH.70

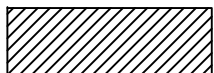

VMQ

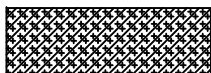

VMQ
ESPANSO



EPDM



EPDM
ESPANSO



NBR



SBR

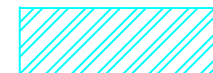

CR

905 EPDM NERO SH.60 	906 VMQ TRASP. SH.55 	907 EPDM NERO SH.60 	908 VMQ BIANCO SH.60 	909 VMQ TRASP. SH.40 	910 VMQ TRASP. SH.60 	911 EPDM GRIGIO SH.70
912 EPDM NERO SH.50 	913 EPDM NERO SH.50 	914 VMQ NERO SH.35 	915 EPDM NERO SH.70 	916 VMQ ROSSO SH.75 	917 NBR NERO SH.70 	918 N.D.
919 N.D.	920 VMQ NERO SH.60 	921 EPDM NERO SH.60 	922 EPDM NERO SH.80 	923 VMQ BIANCO SH.50 	924 EPDM NERO SH.65 	925 VMQ GRIGIO SH.60
926 EPDM NERO SH.50 	927 NBR NERO SH.70 	928 EPDM NERO SH.80 	929 EPDM NERO SH.75 	930 VMQ ESP. GR. DS.0,50 	931 VMQ NERO SH.30 	932 VMQ B.CO SH.60
933 NBR NERO SH.70 	934 VMQ ESP. DS.0,45 	935 EPDM NERO SH.60 	936 EPDM NERO SH.70 	937 VMQ ESP. B.CO DS.0,6 	938 VMQ ROSSO SH.70 	939 VMQ NERO SH.60



VMQ

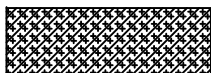

VMQ
ESPANSO



EPDM



EPDM
ESPANSO

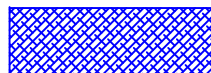







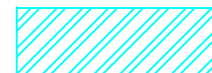



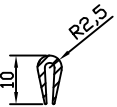
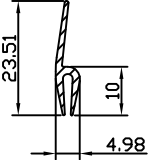
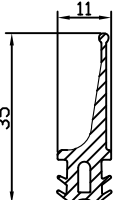
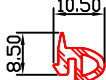
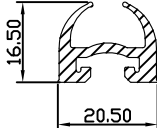
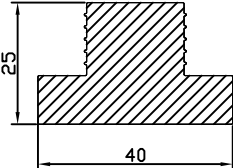
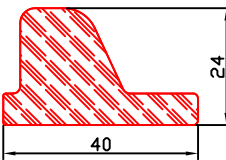
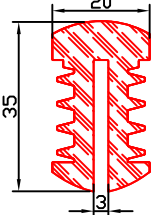

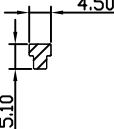
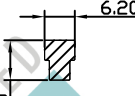
NBR

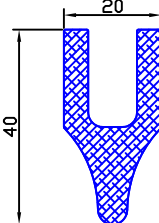
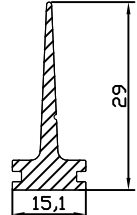
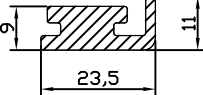
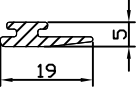
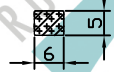

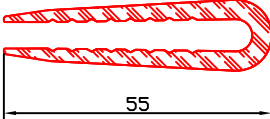
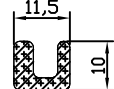
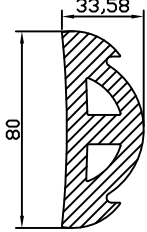

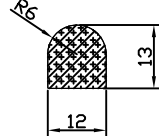

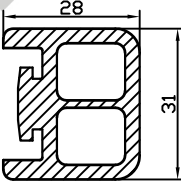
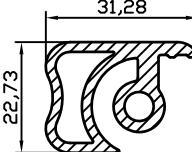
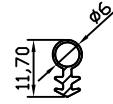

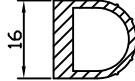
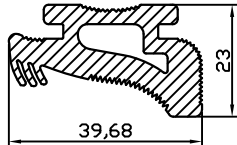
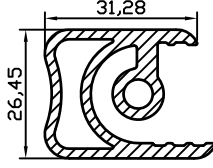
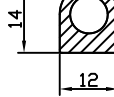
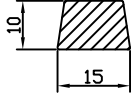

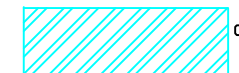
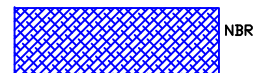
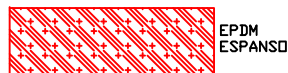
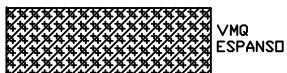
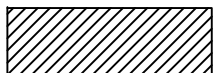
SBR

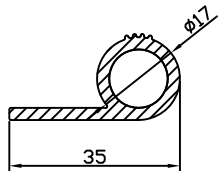

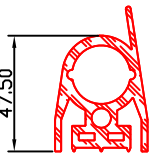
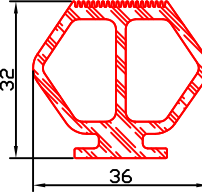
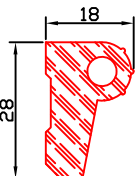
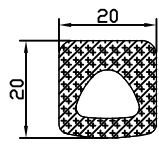
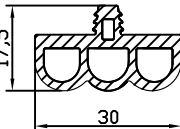
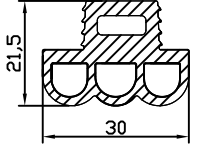
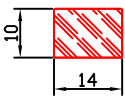
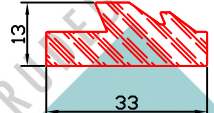
CR

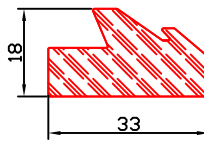
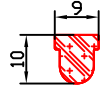
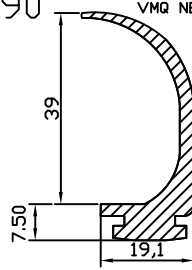
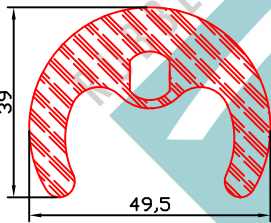
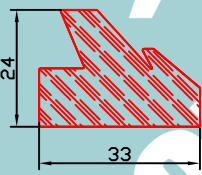
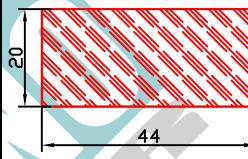
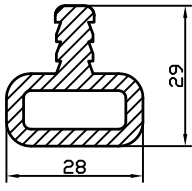
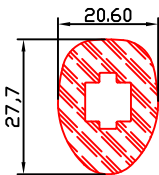
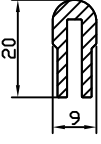
940 VMQ SH.30 	941 VMQ SH.30 	942 VMQ GRIGIO SH.60 	943 EPDM NERO 60 	944 VMQ GRIGIO SH.60 	945 VMQ TRASP. SH.60 	946 EPDM NERO SH.60 
947 EPDM NERO SH.60 	948 VMQ ESP. DS.0,7 	949 VMQ ROSSO SH.60 	950 VMQ TRASP. SH.80 	951 VMQ NERO SHA.60 	952 NBR SHA.70 	953 VMQ SH.50 
954 VMQ SH.60 	955 VMQ SH.60 	956 VMQ ESP. DS.0,7 	957 VMQ ESP. DS.0,7 	958 VMQ ESP. DS.0,7 	959 EPDM SH.70 	960 VMQ ESP. DS.0,5 
961 EPDM NERO SH.70 	962 VMQ ESP DS.0,8 	963 VMQ ESP. DS.0,6 	964 EPDM SH.60 	965 VMQ B.CO/NERO SH.40 	966 VMQ NERO SH.60 	967 VMQ B.CO/MARRO. SH.60 
968 VMQ NERO SH.60 	969 VMQ NERO SH.60 	970 N.D.	971 VMQ SH.35 	972 VMQ NERO SH.60 	973 VMQ BIANCO SH.55 	974 VMQ ROSSO SH.65 

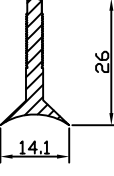

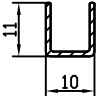
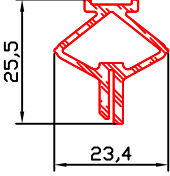
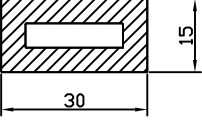
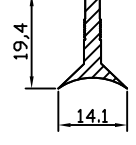
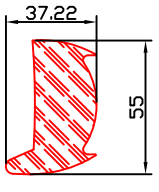
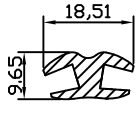
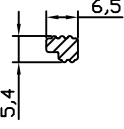
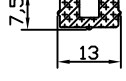
975 VMQ ROSSO SH.60 	976 EPDM NERO SH.50 	977 VMQ ESP. DS.0,50 	978 EPDM SH.70 	979 EPDM SH.70 	980 EPDM SH.50 	981 VMQ ESP. DS.0,50 
982 VMQ NERO SH.60 	983 VMQ NERO SH.60 	984 EPDM NERO SH.70 	985 EPDM NERO SH.60 	986 VMQ ESP. DS.0,5 	987 VMQ NERO SH.60 	988 EPDM NERO SH.70 
989 EPDM ESP. DS.0,40 	990 VMQ NERO SH. 60/70 	991 EPDM NERO SH.80 	992 EPDM NERO SH.70 	993 EPDM NERO SH.70 	994 VMQ NERO SH.40 	995 EPDM NERO SH.70 
996 VMQ TRASP. AL. SH.50 	997 VMQ B.CD SH.60 	998 VMQ B.CD SH.60 	999 VMQ B.CD SH.60 	1000 VMQ B.CD SH.60 	1001 VMQ NERO SH.60 	1002 EPDM NERO SH.60 
1003 VMQ NERO HT SH.60 	1004 VMQ B.CD SH.60 	1005 EPDM B.CD SH.70 	1006 VMQ TRASP. SH.60 	1007 VMQ TRASP. SH.80 	1008 VMQ ESP. NERO DS.0,5 	1009 /

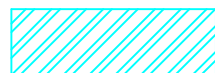
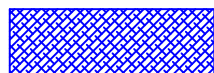
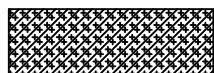

VMQ

VMQ
ESPANSO







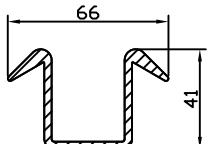
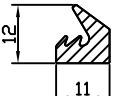
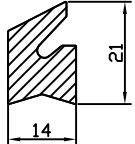
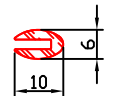
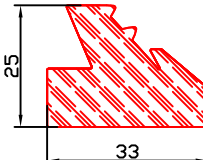
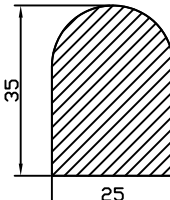

EPDM

EPDM
ESPANSO

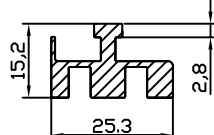
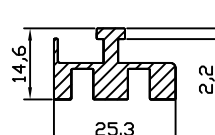
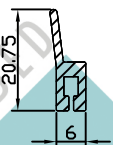
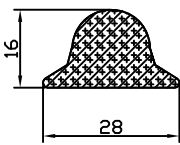
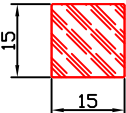
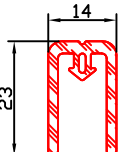
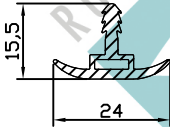
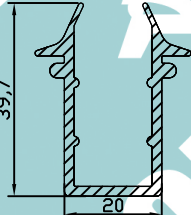
NBR

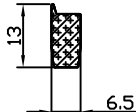
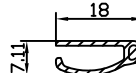
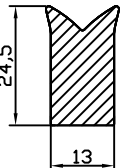
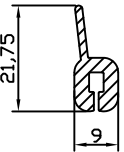
SBR

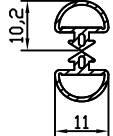
CR

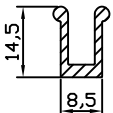
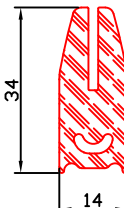
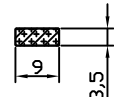
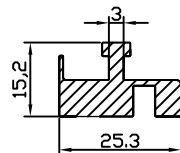
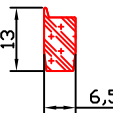
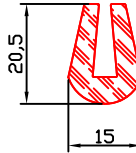
1010 VMQ TRASP. SH.60 	1011 VMQ TRASP. 60 	1012 VMQ TRASP. 65 	1013 VMQ ROSSO SH.75 	1014 EPDM NERO SH.60 	1015 EPDM NERO SH.70 	1016 VMQ TRASP. SH.40 
1017 VMQ ESP. B.CO DS.0,5 	1018 VMQ THERMIC NERO SH.80 	1019 VMQ THERMIC NERO SH.80 	1020 VMQ B.CO SH.60 	1021 VMQ ESP. NERO DS.0,45 	1022 EPDM NERO SH.65 	1023 N.D.
1024 EPDM NERO SH.70 	1025 N.D.	1026 VMQ NERO SH.60 	1027 VMQ BLU SH.70 	1028 EPDM NERO SH.70 	1029 VMQ ESP. DS.0,5 	1030 VMQ NERO HT/THE SH.70 
1031 VMQ ROSSO VAP SH.70 	1032 VMQ B.CO SH.75 	1033 EPDM NERO SH.60 	1034 VMQ THERMIC NERO SH.80 	1035 VMQ ROSSO VAP. SH.50 	1036 N.D.	1037 VMQ ESP. DS.0,5 
1038 EPDM NERO SH.70 	1039 EPDM NERO SH.80 	1040 VMQ ESP. DS.0,50 	1041 VMQ THERMIC NERO SH.80 	1042 N.D.	1043 EPDM ESP. DS.0,5 	1044 EPDM NERO SH.70 



VMQ

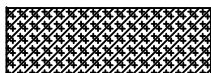

VMQ
ESPANSO



EPDM



EPDM
ESPANSO

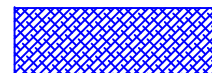







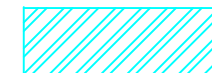

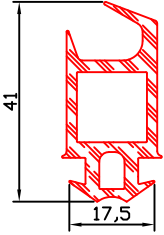
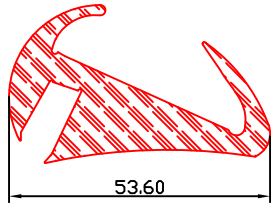
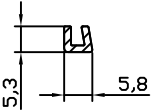
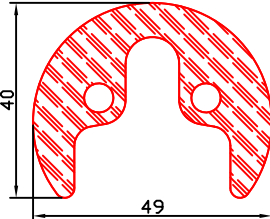

NBR

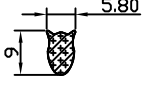
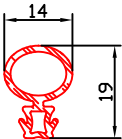
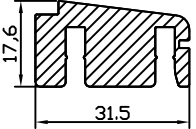
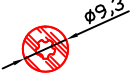
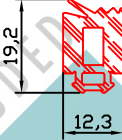
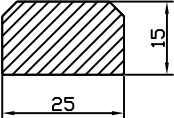
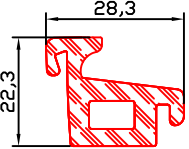

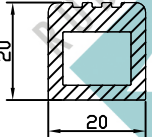

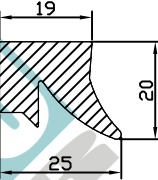
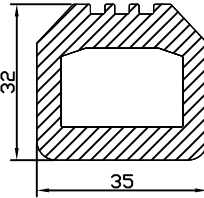
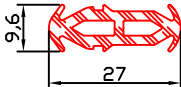
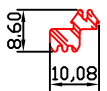
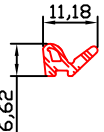
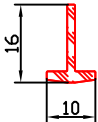

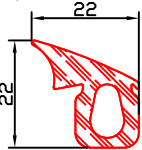

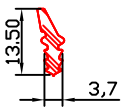
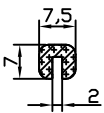
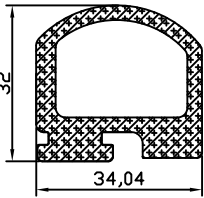
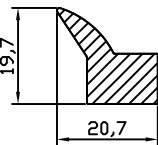
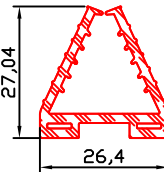
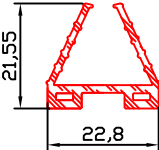
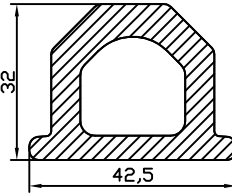

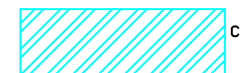
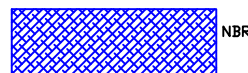
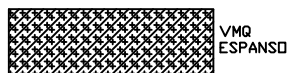
SBR

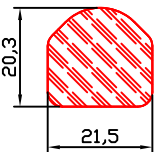
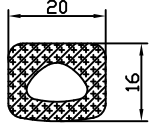
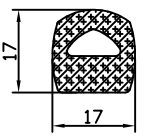

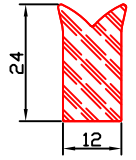
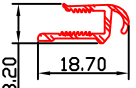
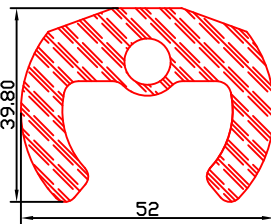
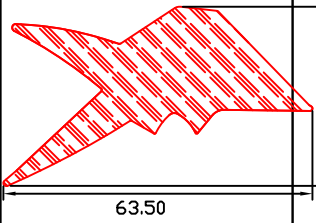
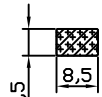
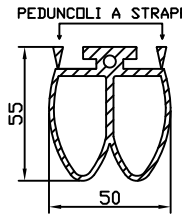
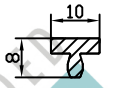
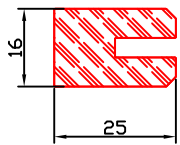

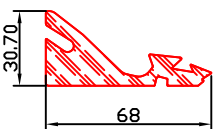

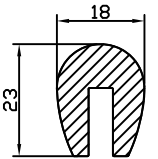
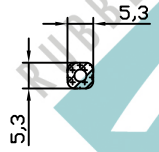
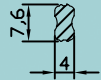

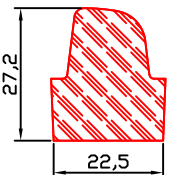
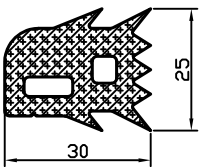
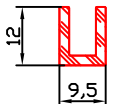
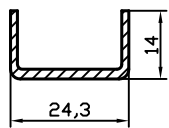
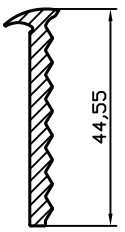
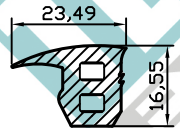
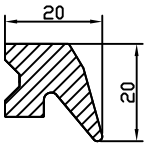
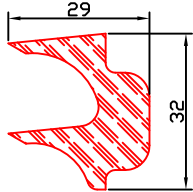
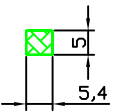
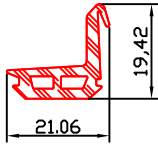
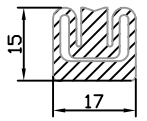
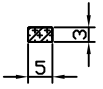
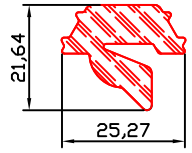
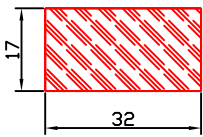
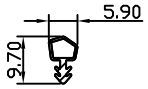

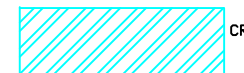
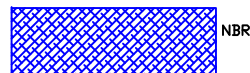
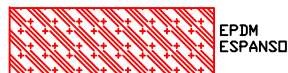
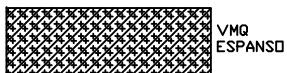

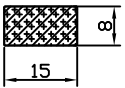
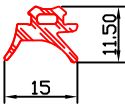
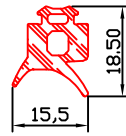
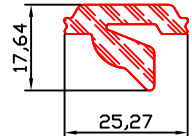
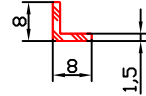
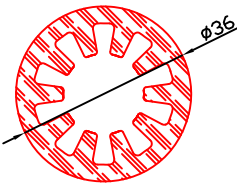

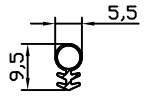

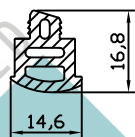
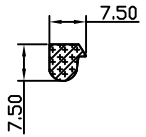
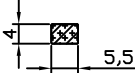
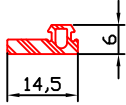

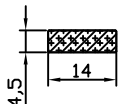
CR

1045 EPDM NERO SH.70 	1046 EPDM NERO SH.70 	1047 VMQ NERO SH.55 	1048 N.D.	1049 EPDM NERO SH.80 	1050 VMQ ESP. GR. DS.0,50 	1051 VMQ ESP. GR. DS.0,50 
1052 EPDM GR. SH.65 	1053 VMQ NERO SH.60 	1054 EPDM GR. SH.70 	1055 EPDM NERO SH.60 	1056 VMQ B.CO SH.30 	1057 N.D.	1058 VMQ TRASP. SH.60 N.D.
1059 EPDM NERO SH.60 	1060 VMQ ESP. GR. DS.0,50 	1061 VMQ ROSSO SH.60 	1062 VMQ ROSSO SH.60 	1063 VMQ ROSSO SH.60 	1064 VMQ ROSSO SH.60 	1065 EPDM NERO SH.70 
1066 EPDM NERO SH.70 	1067 EPDM NERO SH.70 	1068 EPDM NERO SH.70 	1069 EPDM NERO SH.60 	1070 EPDM NERO SH.60 	1071 EPDM NERO 70 	1072 N.D.
1073 EPDM NERO 70 	1074 VMQ ESP. NERO DS.0,50 	1075 VMQ ESP. NERO DS.0,45 	1076 VMQ ROSSO SH.60 	1077 EPDM NERO SH.60 	1078 EPDM NERO SH.60 	1079 VMQ TRASP. SH.60 

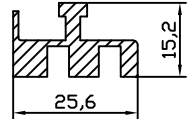
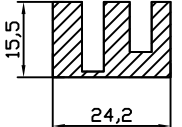
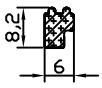
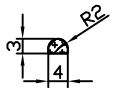
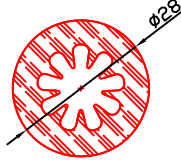

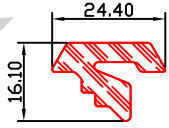
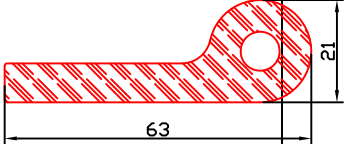
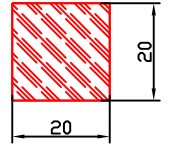
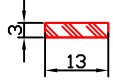
1080 EPDM NERO SH.80 	1081 VMQ ESP. B.CO DS.0,5 	1082 VMQ ESP. B.CO DS.0,5 	1083 EPDM ESP. NERO DS.0,5 	1084 EPDM NERO SH.70 	1085 EPDM NERO SH.60 	1086 EPDM NERO SH.80 
1087 EPDM NERO SH.65 	1088 VMQ ESP. GR. DS.0,5 	1089 VMQ GRIGIO SH.70 PEDUNCOLI A STRAPPD 	1090 VMQ ROSSO SH.60 	1091 EPDM NERO SH.60 	1092 VMQ ESP. GR. DS.0,55 	1093 EPDM NERO SH.60 
1094 EPDM NERO SH.65 	1095 VMQ TRASP. SH.60 	1096 VMQ ESP. NERO DS.0,45 	1097 VMQ GRIGIO SH.50 	1098 VMQ TRASPARENTE SH.60 	1099 EPDM NERO SH.80 	1100 VMQ ESP. B.CO DS.0,60 
1101 EPDM NERO SH.60 	1102 VMQ GR. RAL.7047 SH.75 	1103 VMQ GR. RAL.7047 SH.75 	1104 VMQ GR. RAL.7047 SH.75 	1105 VMQ ROSSO SH.60 	1106 EPDM NERO SH.50 	1107 SBR NERO SH.70 
1108 EPDM NERO SH.60 	1109 VMQ NERO SH.60 	1110 VMQ ESP. GR. DS.0,6 	1111 EPDM NERO SH.60 	1112 N.D.	1113 EPDM NERO SH.80 	1114 VMQ NERO SH.50 

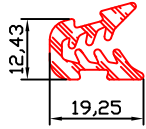
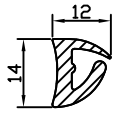

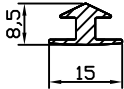
1115 VMQ ESP. B.CO DS.0,50 	1116 EPDM NERO SH.60 	1117 EPDM NERO SH.60 	1118 EPDM NERO SH.60 	1119 EPDM NERO SH.65 	1120 EPDM NERO SH.60 	1121 NBR NERO SH.40 
1122 EPDM NERO SH.60 	1123 VMQ MARRONE SH.50 	1124 VMQ GRIGIO SH.60 	1125 VMQ NERO SH.50 	1126 VMQ ESP. GR. DS.0,50 	1127 VMQ ESP. GR. DS.0,50 	1128 EPDM NERO SH.70 
1129 VMQ NATURALE SH.70 	1130 VMQ ESP. B.CO DS.0,50 	1131 EPDM ESP. NERO DS.0,50 	1132 VMQ NERO SH.50 	1133 VMQ ROSSO SH.70 	1134 VMQ THERMIC NERO SH.80 	1135 VMQ THERMIC NERO SH.80 
1136 VMQ ESP. B.CO DS.0,70 	1137 VMQ ESP. NERO DS.0,50 	1138 EPDM NERO SH.70 	1139 EPDM ESP. NERO DS.0,60 	1140 EPDM NERO SH.60 	1141 EPDM NERO SH.70 	1142 EPDM NERO SH.80 
1143 EPDM NERO SH.65 	1144 N.D.	1145 EPDM NERO SH.60 	1146 EPDM NERO SH.60 	1147 VMQ GR. RAL7047 SH.65 	1148 EPDM GR. SH.70 	1149 VMQ MARRONE SHA.70 



VMQ

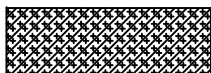

VMQ
ESPANSO



EPDM



EPDM
ESPANSO

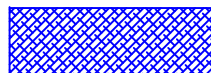

NBR



SBR

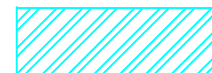

CR

1150 VMQ BIANCO SH.60 	1151 EPDM NERO SH.70 	1152 EPDM NERO SH.70 	1153 VMQ ROSSO SH.40 	1154 EPDM NERO SH.70 	1155 VMQ ESP. NERO DS.0,60 	1156 EPDM NERO SH.60
1157 EPDM NERO SH.60 	1158 VMQ NERO SH.50 	1159 EPDM NERO SH.60 	1160 VMQ TRASP. SH.70 	1161 EPDM NERO SH.65 	1162 EPDM NERO SH.60 	1163 EPDM NERO SH.80
1164 EPDM NERO SH.80 	1165 EPDM ESP. NERO DS.0,50 	1166 VMQ B.CO SH.50 	1167 EPDM NERO SH.80 	1168 VMQ NERO SH.60 	1169 EPDM NERO SH.80 	1170 VMQ ESP. BIANCO DS.0,50
1171 VMQ ESP. NERO DS.0,60 	1172 VMQ NERO SH.60 	1173 EPDM NERO SH.60 	1174 EPDM ESP. NERO DS.0,50 	1175 EPDM NERO SH.70 	1176 N.D.	1177 VMQ ESP.GRIGIO DS.0.6
1178 EPDM BLU R5003 SH.80 	1179 VMQ NERO SH.50 	1180 EPDM ESP. NERO DS.0.5 	1181 EPDM NERO SH.70 	1182 EPDM BLU R5003 SH.80 	1183 VMQ TRASP. SH.65 	1184 VMQ GR. R7035 SH.50

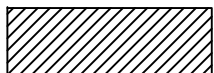

VMQ

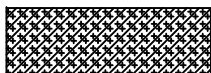

VMQ
ESPANSO



EPDM



EPDM
ESPANSO







NBR

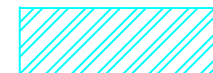

SBR

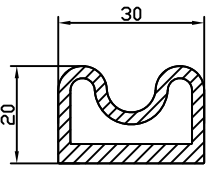
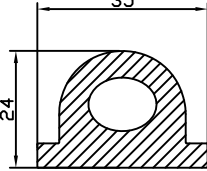
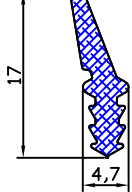
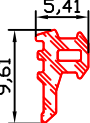
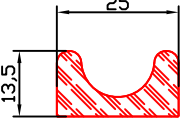
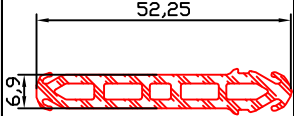
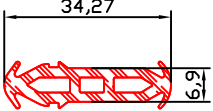
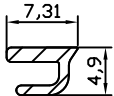
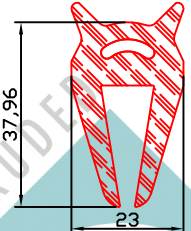
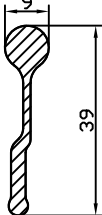
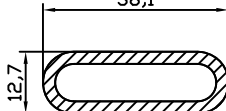
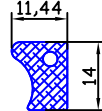
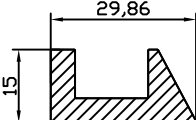
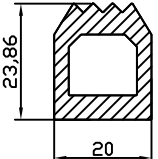

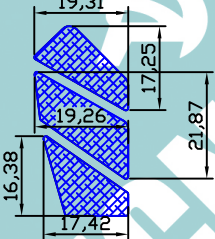
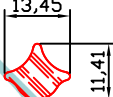
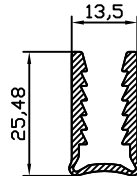
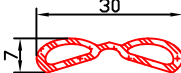
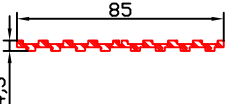
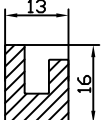
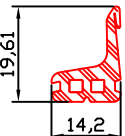
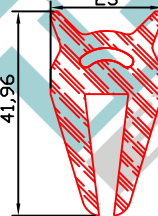
CR

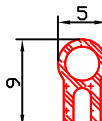
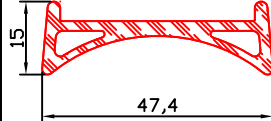
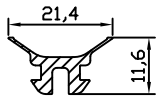
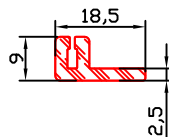
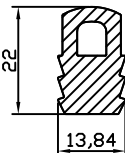
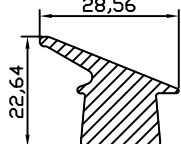
1185 VMQ ROSSO SH 60 	1186 VMQ ROSSO SH 60 	1187 NBR OZONO SH 70 	1188 EPDM NERO SH 60 	1189 EPDM NERO SH 70 	1190 EPDM NERO SH 70 	1191 N.D.
1192 N.D.	1193 EPDM NERO SH 70 	1194 VMQ NERO SH 60 	1195 EPDM NERO SH 70 	1196 VMQ NERO HL SH 70 	1197 VMQ NERO HL SH 60 	1198 NBR NERO SH 80 
1199 VMQ BIANCO SH 70 	1200 VMQ ROSSO HL SH 60 	1201 VMQ NERO HL SH 70 	1202 NBR NERO SH 80 	1203 EPDM NERO SH 70 	1204 VMQ R7047 SH 80 	1205 EPDM ESP NERO D 0,5 
1206 EPDM NERO SH 60 	1207 VMQ TRASP. SH 60 	1208 EPDM NERO SH 70 	1209 EPDM NERO SH 70 	1210 EPDM NERO SH 70 	1211 N.D.	1212 N.D.
1213 N.D.	1214 EPDM NERO ESP ds 0,8 	1215 EPDM NERO SH 70 	1216 VMQ RAL 7000 sh 75, 	1217 EPDM NERO SH 60 	1218 VMQ ROSSO sh 65 	1219 VMQ ROSSO HT FDA SH 50 

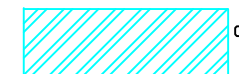
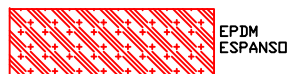
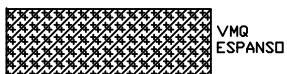

1220 VMQ TRASP SH 55 	1221 VMQ NERO SH 55 	1222 VMQ ROSSO SH 60 	1223 VMQ NERO SH 50 	1224 EPDM NERO sh 60. 	1225 EPDM NERO SH 60 	1226 EPDM NERO SH 60
1227 EPDM NERO SH 60 	1228 VMQ RAL 7021 SH 60 	1229 VMQ BIANCO SH 65. 	1230 VMQ TRASP. SH 60 	1231 VMQ NERO sh 70. 	1232 VMQ ROSSO sh 50. 	1233 VMQ TRAP sh 60.
1234 VMQ Autoest. sh 65. 	1235 VMQ NERO sh 60. 	1236 VMQ NERO sh 50. 	1237 VMQ NERO sh 60. 	1238 VMQ TRASP. sh 60. 	1239 VMQ ROSSO SH 60. 	N.D.
1241 EPDM NERO SH 70. 	1242 VMQ TRASP. SH 60. 	1243 VMQ BIANCO SH 60. 	1244 VMQ NERO SH 60. 	1245 VMQ ARANCIO SH 60. 	1246 VMQ ARANCIO SH 60. 	1247 VMQ ROSSO SH 60.
1248 VMQ NERO HT SH 60. 	1249 VMQ NERO SH 60. 	1250 VMQ BIANCO SH 60. 	1251 VMQ ROSSO SH 40 	1252 N.D.	1253 EPDM NERO SH 70 	1254 VMQ NERO THT SH 60

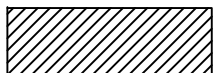

VMQ

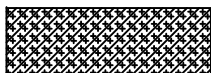

VMQ
ESPANSO



EPDM



EPDM
ESPANSO

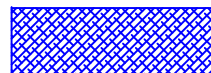

NBR



SBR

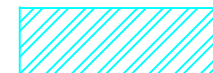

CR

<p>1255 VMQ NERO THT SH 60.</p>	<p>1256 VMQ ROSSO SH 60.</p>	<p>1257 VMQ RAL 5014 SH 70.</p>	<p>1258 VMQ RAL 5014 SH 70.</p>	<p>1259 VMQ RAL 5014 SH 70.</p>	<p>1260 EPDM NERO SH 70</p>	<p>1261 VMQ NERO SH 40.</p>
<p>1262 VMQ R7004 AL SH 60.</p>	<p>1263</p> <p>N.D.</p>	<p>1264 EPDM NERO ESP D. 0.5</p>	<p>1265 VMQ BIANCO ESP D 0.6</p>	<p>1266 EPDM NERO SH 60</p>	<p>1267 VMQ RAL 7001 SH 40.</p>	<p>1268 EPDM ESP NERO D.0.55</p>
<p>1269 VMQ ROSSO SH 60.</p>	<p>1270 VMQ TRASP. SH 50</p>	<p>1271 NBR OZONO SH 70.</p>	<p>1272 EPDM NERO SH 70.</p>	<p>1273 EPDM ESP. D 0.5.</p>	<p>1274 EPDM NERO SH 60.</p>	<p>1275 EPDM NERO SH 70</p>
<p>1276 EPDM NERO SH 60</p>	<p>1277 EPDM NERO SH 60</p>	<p>1278 VMQ BIANCO ESP D 0.6</p>	<p>1279 EPDM NERO ESP D. 0.6</p>	<p>1280 VMQ BIANCO ESP D 0.7</p>	<p>1281 VMQ TRASP. SH 60</p>	<p>1282 EPDM NERO SH 80</p>
<p>1283 VMQ NERO SH 60</p>	<p>1284 VMQ TRASP. SH 60</p>	<p>1285 VMQ NERO SH 60</p>	<p>1286 EPDM NERO SH 60</p>	<p>1287 VMQ BLU SH 50</p>	<p>1288 VMQ GRIGIO SH 65</p>	<p>1289 VMQ NERO SH 65</p>

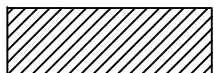

VMQ

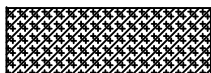

VMQ
ESPANSO



EPDM



EPDM
ESPANSO

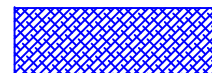







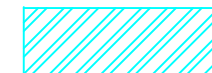

NBR

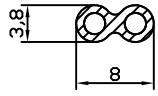
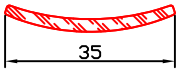
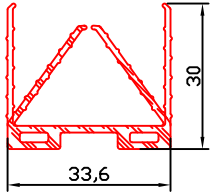
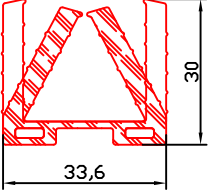
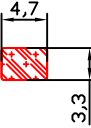
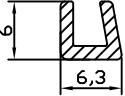

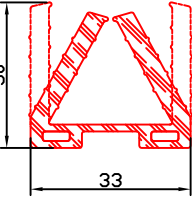
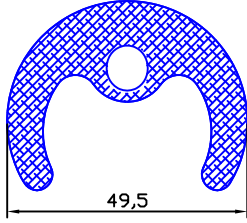
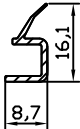
SBR

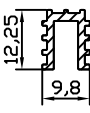

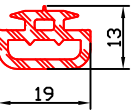
CR

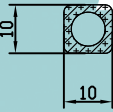
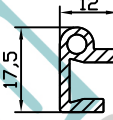
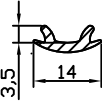
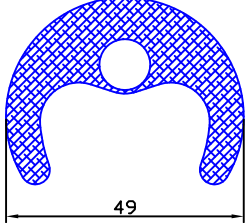
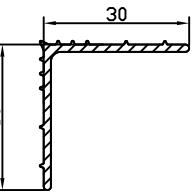
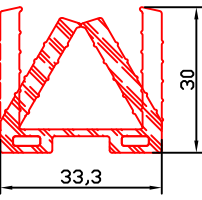
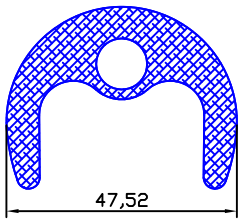
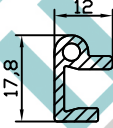
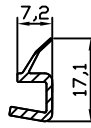
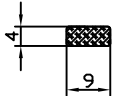
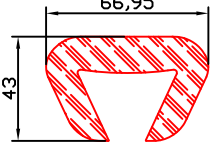
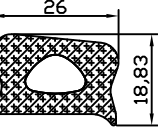
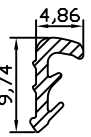
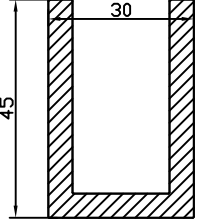
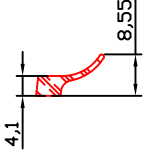
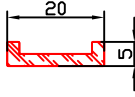
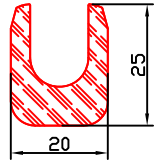
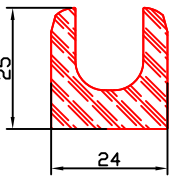
1290 VMQ ROSSO SH 65 	1291 EPDM NERO SH 70 	1292 EPDM NERO SH 60 	1293 EPDM NERO SH 60 	1294 EPDM NERO ESP. D.0,55 	1295 VMQ GRIGIO SH 60. 	1296 EPDM NERO SH 80. 
1297 EPDM NERO SH 60. 	1298 NBR NERO SH 80. 	1299 VMQ NERO SH 60. 	1300 VMQ NERO SH 50 	1301 VMQ TRASP. SH 60 	1302 N.D.	1303 VMQ TRASP. SH 60. 
1304 EPDM NERO SH 60. 	1305 VMQ GRIGIO SH 60 	1306 VMQ BIANCO SH 70. 	1307 VMQ GRIGIO ESP DS 0,6 	1308 VMQ NERO SH 60. 	1309 VMQ BIANCO SH 70. 	1310 NBR NERO SH 80. 
1311 VMQ ROSSO SH 70. 	1312 EPDM NERO SH 60 	1313 NBR NERO SH 80. 	1314 VMQ NERO SH 60. 	1315 VMQ GRIGIO SH 80 	1316 VMQ ESP BIANCO. D 0,5 	1317 EPDM NERO SH 70 
1318 VMQ ESP GRIGIO D 0,6 	1319 VMQ NERO SH 50 	1320 VMQ TRASP. SH 65 	1321 EPDM NERO SH 80 	1322 EPDM NERO SH 70 	1323 EPDM NERO SH 70 	1324 EPDM NERO SH 70 

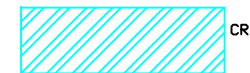
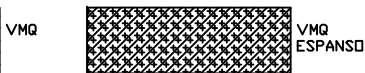
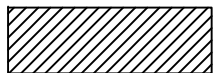

<p>1325 EPDM NERO SH 70.</p>	<p>1326</p> <p>N.D.</p>	<p>1327 VMQ TRASP. SH 70</p>	<p>1328 VMQ NERO SH 60</p>	<p>1329 EPDM NERO SH 70.</p>	<p>1330 VMQ ESP. BIANCO D 0.5</p>	<p>1331 VMQ TRASP. SH 70.</p>
<p>1332 EPDM NERO SH 70.</p>	<p>1333 VMQ TRASP. SH 60</p>	<p>1334 EPDM ESP. NERO D 0.5.</p>	<p>1335 EPDM NERO SH 70</p>	<p>1336 EPDM NERO SH 60</p>	<p>1337 VMQ GRIGIO SH 70.</p>	<p>1338 EPDM ESP. NERO D 0.6</p>
<p>1339 VMQ GRIGIO SH 60</p>	<p>1340 EPDM NERO SH 70.</p>	<p>1341 VMQ NERO SH 40</p>	<p>1342 VMQ NERO SH 40</p>	<p>1343 EPDM NERO SH 70.</p>	<p>1344 VMQ NERO. SH 60</p>	<p>1345</p>
<p>1346 EPDM NERO SH 70.</p>	<p>1347 VMQ ESP D 0.55</p>	<p>1348 VMQ ESP D 0.5</p>	<p>1349 VMQ NERO SH 60</p>	<p>1350 VMQ TRASP. SH 60</p>	<p>1351 VMQ ROSSO HL SH 60</p>	<p>1352 VMQ ROSSO SH 60</p>
<p>1353 VMQ NERO SH 60</p>	<p>1354 VMQ ESP D 0.60</p>	<p>1355 VMQ VERDE SH 60</p>	<p>1356 VMQ VERDE SH 60</p>	<p>1357 VMQ VERDE SH 60</p>	<p>1358 VMQ NERO SH 70</p>	<p>1359 VMQ NERO SH 70</p>

AGGIORNAMENTO AL 04/12/2012



VMQ

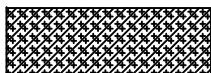

VMQ
ESPANSO



EPDM



EPDM
ESPANSO

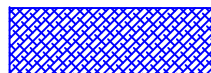

NBR



SBR

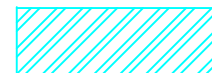

CR

1360 VMQ ESP D 0.55 	1361 VMQ ROSSO SH 60. 	1362 VMQ ROSSO SH 60. 	1363 VMQ ROSSO SH 60. 	1364 VMQ ESP D 0.55 	1365 VMQ NERO SH 60 	1366 N.D.
1367 VMQ ROSSO SH 60. 	1368 VMQ ROSSO SH 60. 	1369 VMQ ROSSO A.L. SH 60. 	1370 VMQ TRASP. SH 55. 	1371 VMQ TRASP. SH 60. 	1372 VMQ ROSSO SH 60. 	1373 EPDM NERO SH 70
1374 VMQ NERO SH 60 	1375 EPDM NERO SH 60 	1376 EPDM NERO SH 70 	1377 VMQ ROSSO SH 60. 	1378 VMQ GRIGIO SH 60. 	1379 EPDM NERO SH 70 	1380 VMQ ROSSO SH 70
1381 VMQ ESP D 0.5 	1382 VMQ ESP D 0.5 	1383 EPDM ESP NERO D 0.55 	1384 EPDM NERO SH 70 	1385 EPDM NERO SH 70 	1386 EPDM NERO SH 70 	1387 EPDM NERO SH 70
1388 EPDM NERO SH 70 	1389 VMQ TRASP. SH 60. 	1390 VMQ NERO SH 60 	1391 VMQ TRASP. SH 60 	1392 NBR NERO SH 70 	1393 VMQ MARRONE SH 60 	1394 VMQ NERO SH 55



VMQ

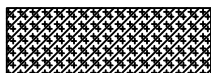

VMQ
ESPANSO



EPDM



EPDM
ESPANSO

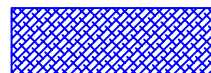





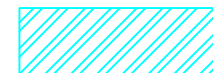

NBR

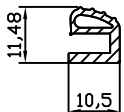
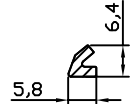
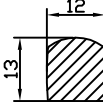
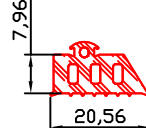
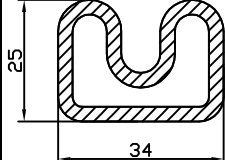
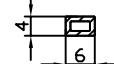
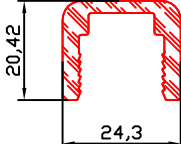
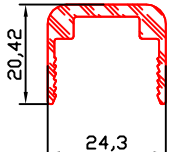
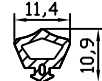
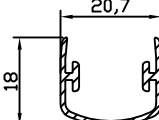
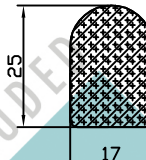
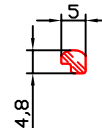
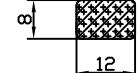
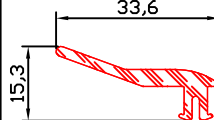

SBR

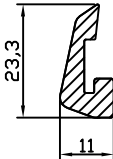
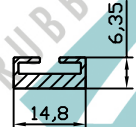

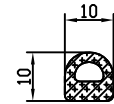
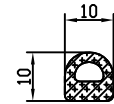
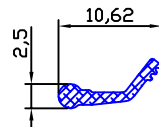
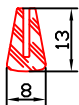
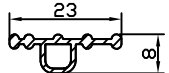
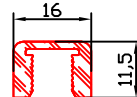
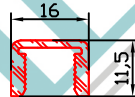
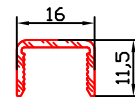
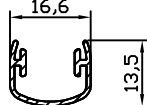
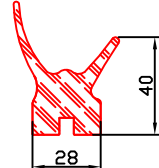
CR

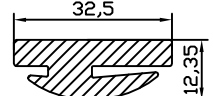
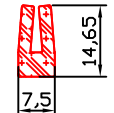
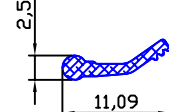
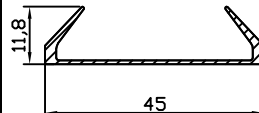
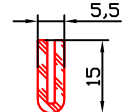
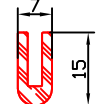
1395 VMQ NERO SH 50 	1396 VMQ GRIGIO SH 60 	1397 VMQ ROSSO SH 60 	1398 EPDM NERO SH 70 	1399 VMQ NERO AL. SH 60 	1400 VMQ ROSSO SH 60 	1401 EPDM NERO SH 70 
1402 EPDM NERO SH 70 	1403 VMQ BIANCO SH 70 	1404 VMQ GRIGIO SH 60 	1405 VMQ ESP D 0.45 	1406 EPDM NERO SH 60 	1407 VMQ ESP D 0.5 	1408 EPDM NERO SH 80 
1409 VMQ GRIGIO SH 45 	1410 VMQ GRIGIO SH 45 	1411 VMQ NERO SH 60 	1412 VMQ NERO SH 70 	1413 	1414 VMQ ESP D 0.5 	1415 NBR NERO SH 60 
1416 EPDM NERO SH 70 	1417 VMQ ROSSO SH 70 	1418 EPDM NERO SH 70 	1419 EPDM NERO SH 70 	1420 EPDM NERO SH 70 	1421 VMQ GRIGIO SH 60 	1422 EPDM NERO SH 70 
1423 VMQ ESP D 0.6 	1424 VMQ GRIGIO SH 50 	1425 EPDM ESP. NERO D0.75 	1426 NBR NERO SH 60 	1427 VMQ GRIGIO SH 70 	1428 EPDM NERO SH 60 	1429 EPDM NERO SH 60 



VMQ

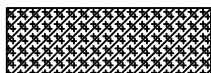

VMQ
ESPANSO



EPDM



EPDM
ESPANSO

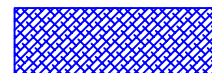

NBR



SBR

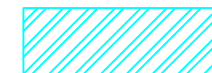

CR

<p>1430 EPDM NERO SH 60</p>	<p>1431 VMQ TRASP. SH 50</p>	<p>1432 VMQ ROSSO SH 60</p>	<p>1433 VMQ NERO HT. SH 50</p>	<p>1434 EPDM NERO SH 60</p>	<p>1435 EPDM NERO SH 60</p>	<p>1436 EPDM NERO SH 60</p>
<p>1437 VMQ GRIGIO SH 50</p>	<p>1438 VMQ BIANCO SH 60</p>	<p>1439 VMQ ROSSO SH 70</p>	<p>1440 VMQ ROSSO SH 70</p>	<p>1441 VMQ ROSSO SH 70</p>	<p>1442 VMQ GRIGIO SH 60</p>	<p>1443 VMQ GRIGIO SH 60</p>
<p>1444 VMQ TRASP. SH 60</p>	<p>1445 VMQ TRASP. SH 70</p>	<p>1446 VMQ BIANCO SH 60</p>	<p>1447 VMQ BIANCO SH 60</p>	<p>1448 EPDM NERO SH 80</p>	<p>1449 VMQ ROSSO SH 70</p>	<p>1450 VMQ ROSSO SH 70</p>
<p>1451 EPDM NERO SH 60</p>	<p>1452 EPDM NERO SH 70</p>	<p>1453 EPDM NERO SH 70</p>	<p>1454 EPDM NERO SH 60</p>	<p>1455 VMQ ROSSO SH 60</p>	<p>1456 VMQ BLU SH 60</p>	<p>1457 VMQ ESP PLT D 0.55</p>
<p>1458 EPDM NERO SH 70</p>	<p>1459 VMQ TRASP. SH 60</p>	<p>1460 VMQ ROSSO SH 70</p>	<p>1461 VMQ GRIGIO SH 60</p>	<p>1462 EPDM NERO SH 60</p>	<p>1463 EPDM NERO SH 80</p>	<p>1464 NBR NERO SH 70</p>



VMQ

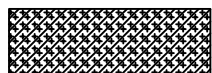

VMQ ESPANSO



EPDM



EPDM ESPANSO

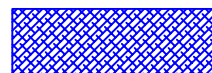

NBR





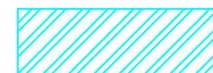

SBR



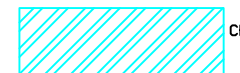
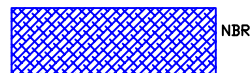
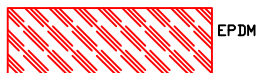
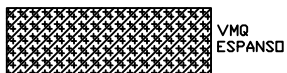

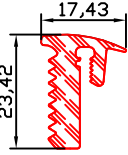
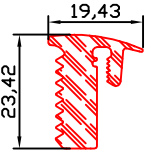
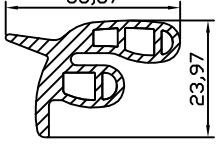
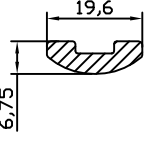
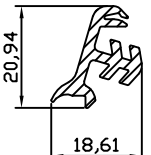

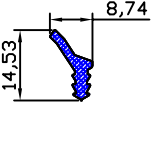
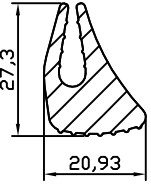
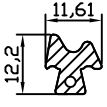
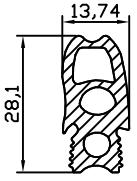
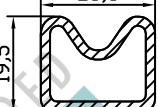
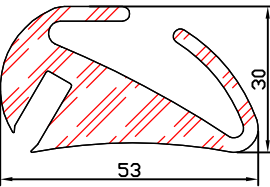
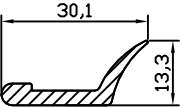
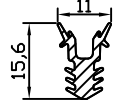
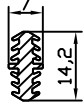
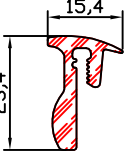

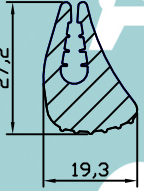
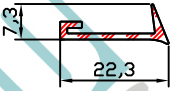
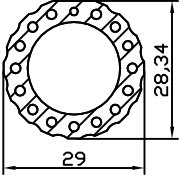
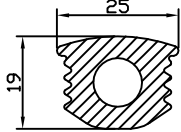
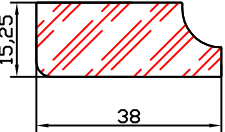
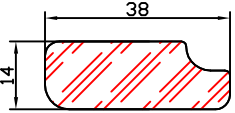
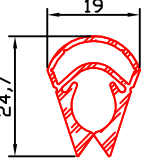
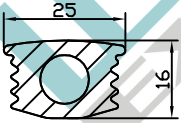
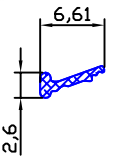
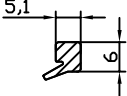
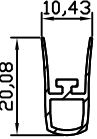
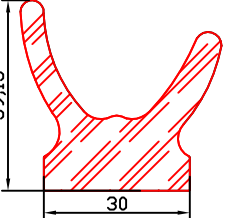
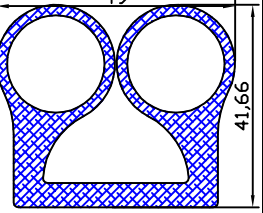
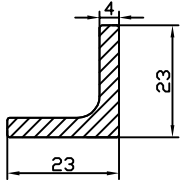
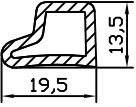
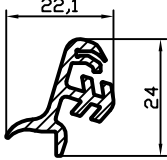
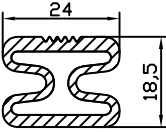
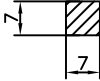
CR

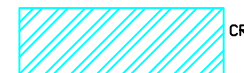
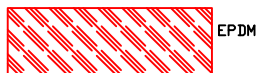
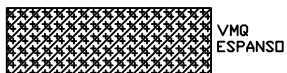
<p>1465 VMQ NERO SH 70</p>	<p>1466 VMQ TRASP. SH 75</p>	<p>1467 VMQ NERO SH 75</p>	<p>1468 VMQ NERO SH 60</p>	<p>1469 VMQ GRIGIO SH 75</p>	<p>1470 VMQ ROSSO SH 70</p>	<p>1471 VMQ THT NERO SH 60</p>
<p>1472 VMQ ESP PLT D 0.55</p>	<p>1473 EPDM NERO SH 80</p>	<p>1474</p>	<p>1475 VMQ TRASP. SH 60</p>	<p>1476 VMQ TRASP. SH 60</p>	<p>1477 VMQ GRIGIO SH 70</p>	<p>1478 VMQ ROSSO SH 60</p>
<p>1479 EPDM NERO SH 60</p>	<p>1480 VMQ NERO SH 60</p>	<p>1481 VMQ GRIGIO SH 60</p>	<p>1482 EPDM NERO SH 70</p>	<p>1483 VMQ TRASP. SH 50</p>	<p>1484 VMQ TRASP. SH 50</p>	<p>1485 EPDM NERO SH 80</p>
<p>1486 EPDM NERO SH 80</p>	<p>1487 VMQ THT ROSSO SH 60</p>	<p>1488 VMQ GRIGIO SH 75</p>	<p>1489 EPDM NERO SH 60</p>	<p>1490 EPDM NERO SH 60</p>	<p>1491 VMQ NERO SH 60</p>	<p>1492 VMQ NERO SH 60</p>
<p>1493 VMQ GRIGIO SH 70</p>	<p>1494 VMQ THT GRIGIO SH 50</p>	<p>1495 VMQ PLA. TRASP. SH 60.</p>	<p>1496 VMQ TRASP. SH 60</p>	<p>1497 EPDM NERO SH 70</p>	<p>1498 EPDM NERO SH 80</p>	<p>1499 EPDM NERO SH 70</p>

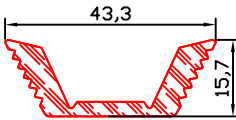
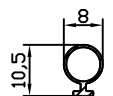
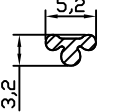
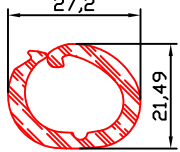
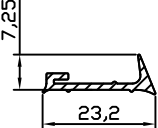
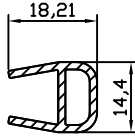
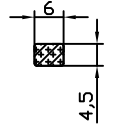
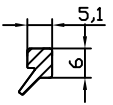
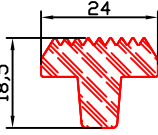

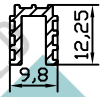
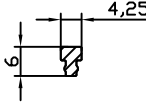
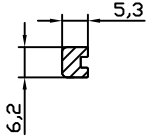
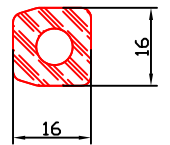
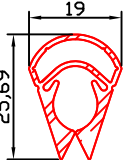
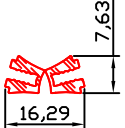
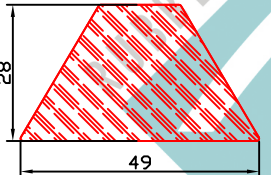
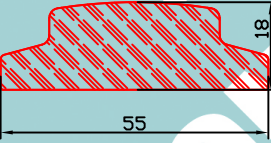
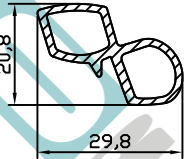
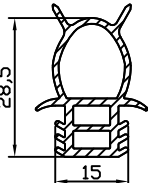
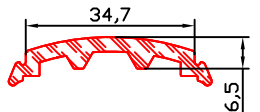
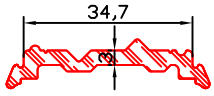
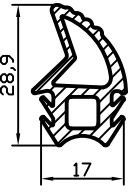
<p>1500 EPDM NERO SH 70</p> 	<p>1501 EPDM NERO SH 70</p> 	<p>1502 VMQ GRIGIO SH 75</p> 	<p>1503 VMQ BLU SH 60</p> 	<p>1504 VMQ GRIGIO SH 60</p> 	<p>1505 EPDM GRIGIO SH 60</p> 	<p>1506 NBR NERO SH 60</p> 
<p>1507 VMQ NERO SH 60</p> 	<p>1508 VMQ BLU SH 60</p> 	<p>1509 VMQ HT GRIGIO SH 50</p> 	<p>1510 VMQ PLAT. TRAS. SH 60</p> 	<p>1511 EPDM NERO SH 60</p> 	<p>1512 VMQ BIANCO SH 60</p> 	<p>1513 VMQ TRASP. SH 70</p> 
<p>1514 VMQ TRASP. SH 50</p> 	<p>1515 EPDM NERO SH 70</p> 	<p>1516 VMQ NERO SH 60</p> 	<p>1517 VMQ NERO SH 60</p> 	<p>1518 EPDM NERO SH 65</p> 	<p>1519 VMQ NERO SH 50</p> 	<p>1520 VMQ BIANCO SH 60</p> 
<p>1521 EPDM NERO SH 80</p> 	<p>1522 EPDM NERO SH 80</p> 	<p>1523 EPDM NERO SH 60</p> 	<p>1524 VMQ BIANCO SH 60</p> 	<p>1525 NBR SH 60</p> 	<p>1526 VMQ TRASP. SH 60</p> 	<p>1527 VMQ GRIGIO SH 70</p> 
<p>1528 EPDM NERO SH 70</p> 	<p>1529 NBR NERO SH 70</p> 	<p>1530 VMQ NERO SH 60</p> 	<p>1531 VMQ GIALLO SH 60</p> 	<p>1532 VMQ GRIGIO SH 80</p> 	<p>1533 VMQ NERO HL SH 60</p> 	<p>1534 VMQ TRASP. SH 60</p> 

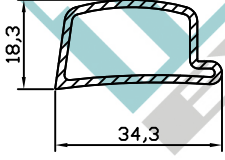
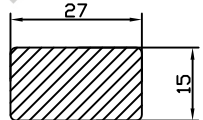
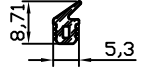
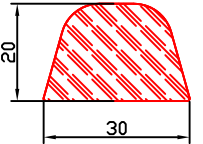

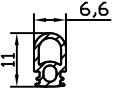
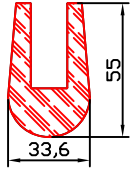
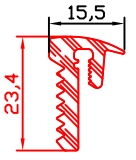
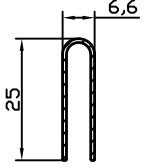
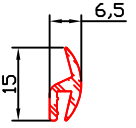
<p>1535 EPDM NERO SH 70</p> 	<p>1536 VMQ HT ROSSO SH 60</p> 	<p>1537 VMQ ROSSO VAP. SH 60</p> 	<p>1538 EPDM NERO SH 80</p> 	<p>1539 VMQ NERO SH 60</p> 	<p>1540 VMQ PLAT.TRAS. SH 60.</p> 	<p>1541 VMQ ESP D 0.5</p> 
<p>1542 VMQ TRASP. SH 50</p> 	<p>1543 EPDM NERO SH 70</p> 	<p>1544 EPDM NERO SH 70</p> 	<p>1545 VMQ NERO SH 60</p> 	<p>1546 VMQ VERDE SH 40.</p> 	<p>1547 VMQ ROSSO SH 70.</p> 	<p>1548 EPDM NERO SH 50.</p> 
<p>1549 EPDM NERO SH 60.</p> 	<p>1550 EPDM NERO SH 60.</p> 	<p>1551 EPDM NERO SH 90</p> 	<p>1552 EPDM NERO SH 90</p> 	<p>1553 VMQ NERO SH 60.</p> 	<p>1554 VMQ GRIGIO .</p> 	<p>1555 EPDM NERO SH 60.</p> 
<p>1556 EPDM NERO SH 60.</p> 	<p>1557 VMQ NERO HT SH 50.</p> 	<p>1558 VMQ ROSSO HT SH 60</p> 	<p>1559 VMQ GIALLO SH 70</p> 	<p>1560 VMQ BIANCO SH 40.</p> 	<p>1561 NBR NERO SH 70.</p> 	<p>1562 EPDM NERO SH 60.</p> 
<p>1563 VMQ ESP NERO D 0.6</p> 	<p>1564 VMQ NERO SH 40.</p> 	<p>1565 VMQ TRASP. SH 60.</p> 	<p>1566 EPDM NERO SH 70</p> 	<p>1567 EPDM NERO SH 80</p> 	<p>1568 VMQ TRASP. SH 60</p> 	<p>1569 EPDM GRIGIO SH 80</p> 



VMQ

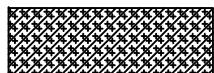

VMQ
ESPANSO



EPDM



EPDM
ESPANSO

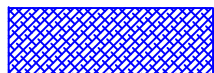





NBR

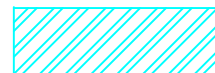

SBR

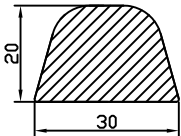
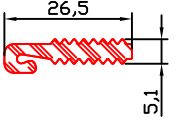
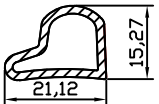
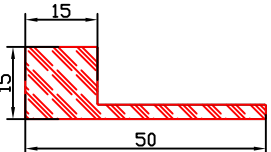
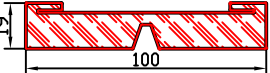
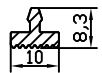
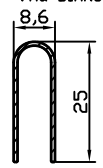
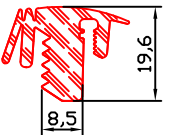

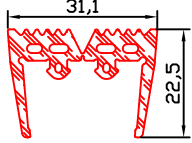
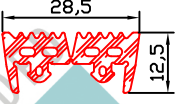
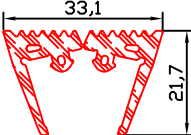
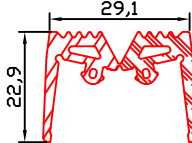
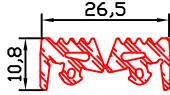
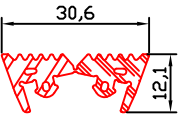
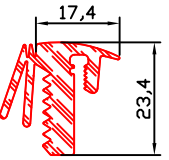
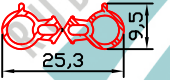
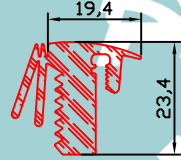
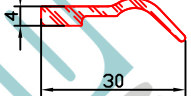
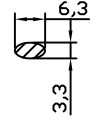
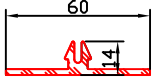
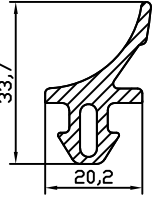
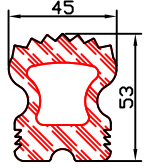
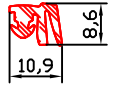
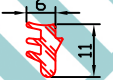
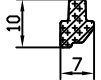
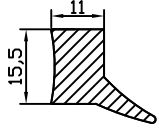
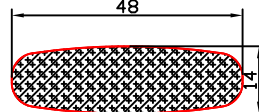
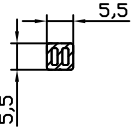
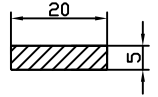
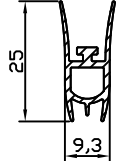
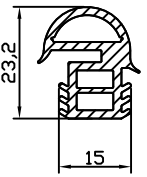
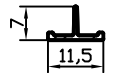
CR

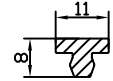
<p>1570 VMQ TRASP. SH 60</p> 	<p>1571 EPDM NERO SH 65.</p> 	<p>1572 VMQ ROSSO SH 70</p> 	<p>1573 EPDM NERO SH 80.</p> 	<p>1574 EPDM NERO SH 70.</p> 	<p>1575 VMQ ROSSO SH 70</p> 	<p>1576 VMQ BIANCO SH 60.</p> 
<p>1577 EPDM NERO SH 70.</p> 	<p>1578 VMQ ESP. GRIGIO D. 0,7.</p> 	<p>1579B EPDM NERO SH 70.</p> 	<p>1580B EPDM NERO SH 70.</p> 	<p>1581B EPDM NERO SH 70.</p> 	<p>1582B EPDM NERO SH 70.</p> 	<p>1583B EPDM NERO SH 70.</p> 
<p>1584B EPDM NERO SH 70.</p> 	<p>1585 EPDM NERO SH 80.</p> 	<p>1586 EPDM NERO SH 80.</p> 	<p>1587 EPDM NERO SH 80.</p> 	<p>1588 EPDM NERO SH 65.</p> 	<p>1589 VMQ ROSSO HT SH50.</p> 	<p>1590 EPDM NERO SH 60.</p> 
<p>1591 VMQ NERO SH 50</p> 	<p>1592 EPDM NERO SH 60.</p> 	<p>1593 EPDM NERO SH 60.</p> 	<p>1594 EPDM NERO SH 65.</p> 	<p>1595 VMQ ESP. DENS. 0,7.</p> 	<p>1596 VMQ ROSSO SH 70.</p> 	<p>1597 VMQ ESP. DENS. 0,55.</p> 
<p>1598 VMQ TRASP SH 70</p> 	<p>1599 VMQ FR 50 sh.</p> 	<p>1600 VMQ GRIGIO SH 70.</p> 	<p>1601 VMQ GRIGIO SH 70</p> 	<p>1602 EPDM NERO SH 70</p> 	<p>1603 VMQ GRIGIO SH 60</p> 	<p>1604 VMQ GRIGIO SH 60</p> 

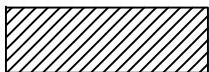

VMQ

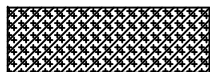

VMQ ESPANSO



EPDM



EPDM ESPANSO

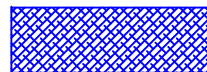

NBR



SBR

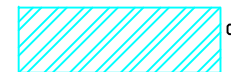

CR

1605 VMQ FR8750 SH 50. 	1606 VMQ ESP.PLT D. 0,5. 	1607 VMQ TRAS. SH 75 	1608 VMQ NERO SH 60 	1609 VMQ NERO SH 80 	1610 VMQ NERO SH 60. 	1611 VMQ TRASP. SH 35
1612 VMQ ESP. DENS 0,6. 	1613 EPDM NERO SH 75. 	1614 VMQ PLAT SH 60. 	1615 VMQ NERO SH 80 	1616 VMQ NERO SH 60 	1617 VMQ GRIGIO SH 70. 	1618 NBR NERO SH 60.
1619 VMQ GRIGIO SH 50. 	1620 VMQ GRIGIO SH 50. 	1621 EPDM NERO SH 70. 	1622 EPDM NERO SH 70. 	1623 VMQ PLAT SH 60. 	1624 VMQ ROSSO SH 60. 	1625 VMQ ROSSO VAP. SH 70.
1626 VMQ GRIGIO SH 50. 	1627 EPDM NERO SH 60. 	1628 VMQ TRASP. SH 60 	1629 EPDM NERO SH 60. 	1630 NBR NERO SH 70. 	1631 EPDM NERO SH 80. 	1632 VMQ NERO HT SH 50.
1633 VMQ NERO HT SH 50. 	1634 VMQ ROSSO HT SH 60. 	1635 EPDM ESP. NERO D 0,5. 	1636 VMQ ESP. BIANCO D.0,5. 	1637 EPDM NERO SH 50 	1638 VMQ GRIGIO SH 60 	1639 VMQ TRASP. SH 60

AGGIORNAMENTO AL 12/04/2016



VMQ

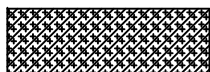

VMQ ESPANSO



EPDM

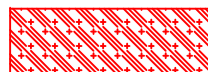

EPDM ESPANSO

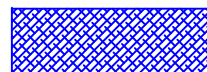





NBR

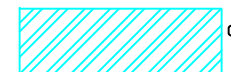

SBR

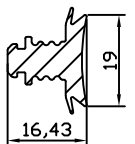
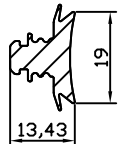
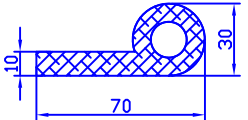

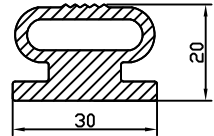
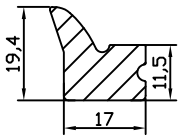
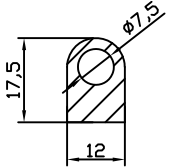
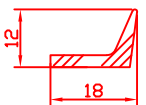
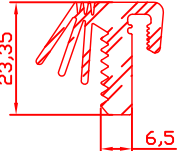
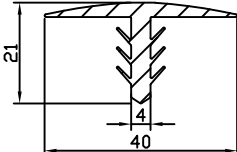
CR

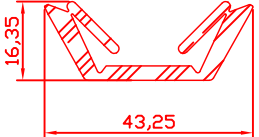
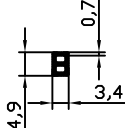
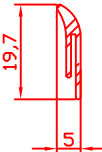
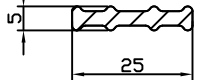
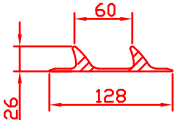
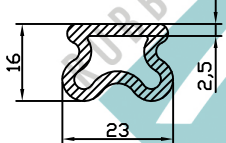
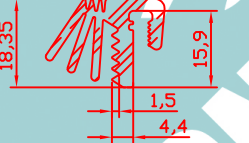
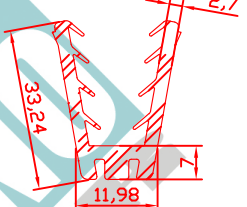
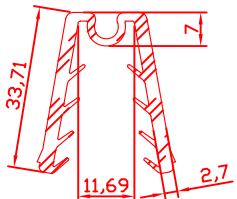
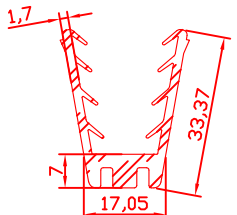
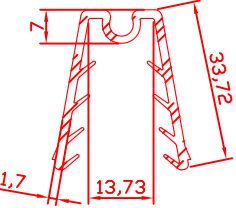
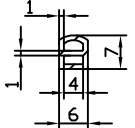
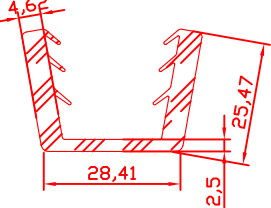
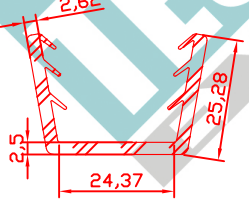
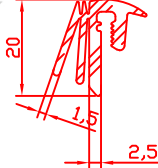
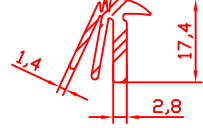
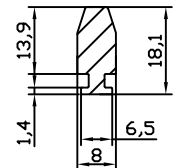
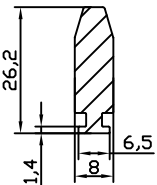
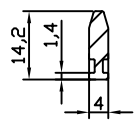
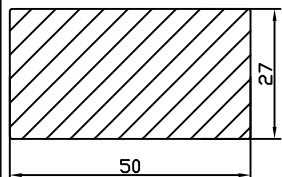
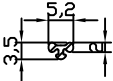
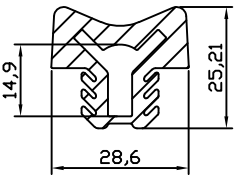
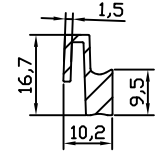
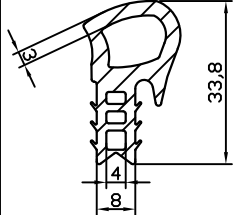
<p>1640 VMQ NERO SH. 60</p> 	<p>1641 VMQ NERO SH. 60</p> 	<p>1642 NBR NERO SH. 60</p> 	<p>1643 EPDM NERO SH. 60</p> 	<p>1644 VMQ ROSSO SH. 55</p> 	<p>1645 VMQ NERO SH. 75</p> 	<p>1646 VMQ BIANCO SH. 55 RAL 9003</p> 
<p>1647 EPDM NERO SH. 68 FIRE RESISTANT</p> 	<p>1648 EPDM NERO SH. 70</p> 	<p>1649 VMQ GRIGIO SH. 60 RAL 7040</p> 	<p>1650 EPDM NERO SH. 60</p> 	<p>1651 EPDM NERO SH. 80</p> 	<p>1652 VMQ VERDE SH. 60 PLATINICO ALIMENTARE</p> 	<p>1653 EPDM NERO SH. 70</p> 
<p>1654 VMQ ROSSO SH. 55</p> 	<p>1655 EPDM GRIGIO SH. 65 RAL 7040</p> 	<p>1656 VMQ TRASP. SH. 60</p> 	<p>1657 EPDM NERO SH. 70</p> 	<p>1658 EPDM NERO SH. 70</p> 	<p>1659 EPDM NERO SH. 70</p> 	<p>1660 EPDM NERO SH. 70</p> 
<p>1661 EPDM NERO SH. 70</p> 	<p>1662 VMQ AZZURRO SH. 60</p> 	<p>1663 EPDM NERO SH. 70</p> 	<p>1664 EPDM NERO SH. 70</p> 	<p>1665 EPDM NERO SH. 70</p> 	<p>1666 EPDM NERO SH. 70</p> 	<p>1667 VMQ MED. AZZURRO SH. 60 PANTONE 2382C</p> 
<p>1668 VMQ MED. AZZURRO SH. 60 PANTONE 2382C</p> 	<p>1669 VMQ MED. AZZURRO SH. 60 PANTONE 2382C</p> 	<p>1670 VMQ BIANCO SH. 60</p> 	<p>1671 VMQ VAPOR ROSSO SH. 70</p> 	<p>1672 VMQ GRIGIO RAL 7042 SH. 50 NON COPRENTE</p> 	<p>1673 VMQ TRASP. SH. 55</p> 	<p>1674 VMQ NERO SH. 50</p> 

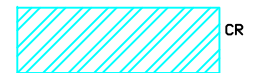
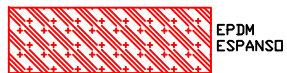

1675 	1676 NBR NERO SH. 60 	1677 EPDM NERO SH. 70 	1678 VMQ HT NERO SH. 50 	1679 VMQ ROSSO SH. 60 	1680 VMQ HT ROSSO SH. 70 	1681 VMQ GRIGIO SH. 60
1682 VMQ NERO SH. 60 PLATINICO 	1683 VMQ HT ROSSO SH. 70 	1684 VMQ TRASP. SH. 60 MEDICALE PLATINICO 	1685 VMQ TRASP. SH. 60 MEDICALE PLATINICO 	1686 EPDM NERO SH. 70 	1687 EPDM NERO SH. 70 	1688 EPDM NERO SH. 60
1689 EPDM NERO SH. 60 	1690 VMQ TRASP. SH. 50 	1691 NBR NERO SH. 60 	1692 EPDM NERO SH. 70 	1693 EPDM NERO SH. 70 	1694 EPDM NERO SH. 70 	1695 EPDM NERO SH. 60
1696 VMQ NERO SH. 50 	1697 VMQ BIANCO SH. 70 PLATINICO 	1698 VMQ ESP. D=0,50 GRIGIO RAL 7035 	1699 EPDM NERO SH. 80 	1700 EPDM NERO SH. 70 	1701 EPDM NERO SH. 70 	1702 VMQ SH. 70 BLU RAL 7015
1703 VMQ SH. 70 BLU RAL 7015 	1704 EPDM NERO SH. 70 	1705 EPDM NERO SH. 70 	1706 VMQ HT NERO SH. 60 	1707 VMQ HT NERO SH. 60 	1708 VMQ HT NERO SH. 60 	1709 EPDM NERO SH. 70

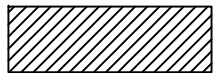

VMQ

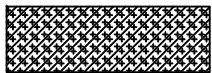

VMQ ESPANSO



EPDM



EPDM ESPANSO

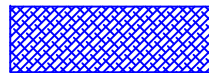

NBR



SBR

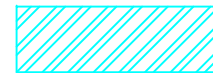

CR

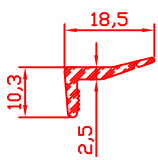
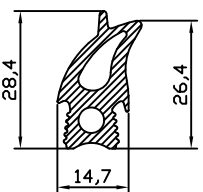
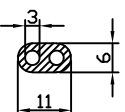
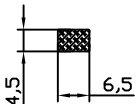
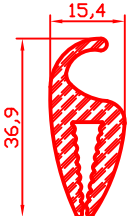
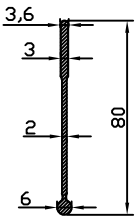
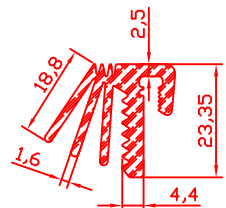
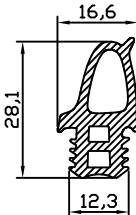
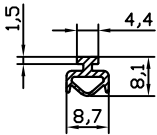
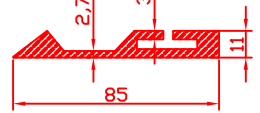
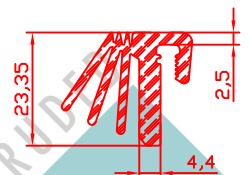
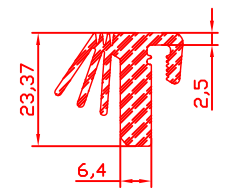
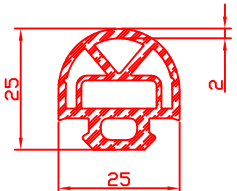
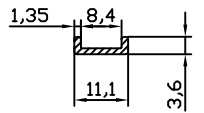
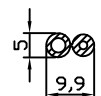
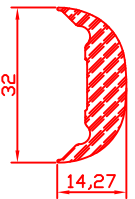
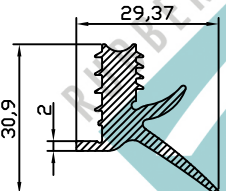
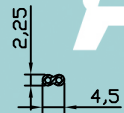
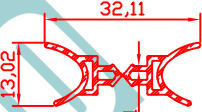
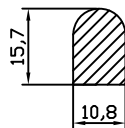
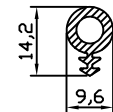
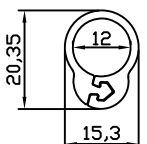
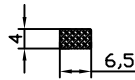
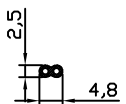
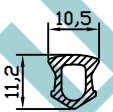
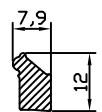
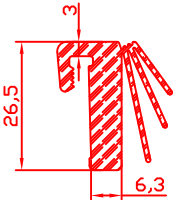
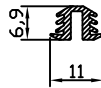
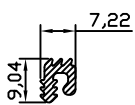
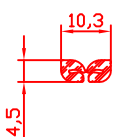
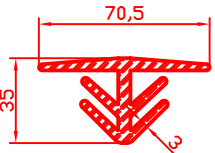
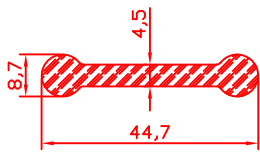
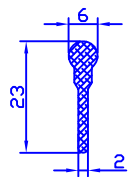
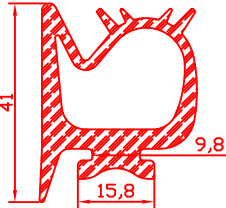
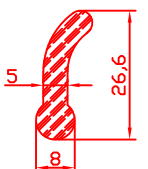
<p>1710 EPDM NERO SH. 70</p> 	<p>1711 VMQ HT SH. 55 GRIGIO A CAMPIONE</p> 	<p>1712 VMQ TRASP. SH. 60 ALTA RESIST. LACER.</p> 	<p>1713 VMQ ESP. PLATINICO BIANCO D=0,55</p> 	<p>1714 EPDM NERO SH. 70</p> 	<p>1715 VMQ NERO SH. 70</p> 	<p>1716 EPDM NERO SH. 80</p> 
<p>1717 VMQ HT NERO SH. 50</p> 	<p>1718 VMQ GRIGIO RAL 7040 SH. 60</p> 	<p>1719 EPDM GRIGIO SH. 80 GRIGIO RAL 7045</p> 	<p>1720 EPDM NERO SH. 80</p> 	<p>1721 EPDM NERO SH. 80</p> 	<p>1722 EPDM NERO SH. 80</p> 	<p>1723 VMQ BIANCO SH. 70 RAL 9016</p> 
<p>1724 VMQ MEDIC. PLAT. TRASP. SH. 70</p> 	<p>1725 EPDM NERO SH. 75</p> 	<p>1726 VMQ HT NERO SH. 60</p> 	<p>1727 VMQ GRIGIO RAL 7040 SH. 65</p> 	<p>1728 EPDM NERO SH. 60</p> 	<p>1729 VMQ TRASP. SH. 50</p> 	<p>1730 VMQ BIANCO RAL 9010 SH. 60</p> 
<p>1731 VMQ GRIGIO SH. 70 RAL 7036</p> 	<p>1732 VMQ ESP. PLAT. BIANCO D=0,60</p> 	<p>1733 VMQ GRIGIO SH. 65 RAL 7040</p> 	<p>1734 VMQ GRIGIO SH. 80 RAL 7040</p> 	<p>1735 VMQ ROSSO SH. 60</p> 	<p>1736 EPDM NERO SH. 90</p> 	<p>1737 VMQ TRASP. SH. 50</p> 
<p>1738 VMQ GRIGIO SH. 60 RAL 7040</p> 	<p>1739 EPDM NERO SH. 60</p> 	<p>1740 EPDM NERO SH. 75</p> 	<p>1741 EPDM NERO SH. 70</p> 	<p>1742 NBR NERO SH. 70</p> 	<p>1743 EPDM NERO SH. 60</p> 	<p>1744 EPDM NERO SH. 60</p> 

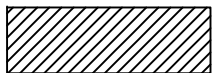

VMQ



VMQ ESPANSO



EPDM



EPDM ESPANSO



NBR



SBR



CR

<p>1745 VMQ HT NERO SH. 60</p>	<p>1746 VMQ HT NERO SH. 60</p>	<p>1747 EPDM NERO SH. 60</p>	<p>1748 VMQ TRASP. PLAT. SH. 50</p>	<p>1749 VMQ NERO SH. 70 ALTA RES. LACER.</p>	<p>1750 EPDM ESP. GRIGIO RAL 7035 D=0,55</p>	<p>1751 VMQ GRIGIO SH. 70 RAL 7036</p>
<p>1752 VMQ GRIGIO SH. 70 RAL 7036</p>	<p>1753 VMQ HT NERO SH. 60</p>	<p>1754 VMQ SH. 50 GRIGIO RAL 7035</p>	<p>1755 EPDM NERO SH. 90</p>	<p>1756 VMQ ESPANSO BIANCO D=0,7</p>	<p>1757 VMQ BIANCO SH. 50 RAL 9003</p>	<p>1758 EPDM NERO SH. 90</p>
<p>1759 EPDM NERO SH. 90</p>	<p>1760 EPDM NERO SH. 60</p>	<p>1761 EPDM NERO SH. 60</p>	<p>1762 EPDM NERO SH. 80</p>	<p>1763 EPDM NERO SH. 80</p>	<p>1764 NBR NERO SH. 60</p>	<p>1765 VMQ BIANCO SH. 70</p>
<p>1766 VMQ GRIGIO SH. 60 RAL 7040</p>	<p>1767 VMQ ESPANSO BIANCO D=0,6</p>	<p>1768 VMQ HT NERO SH. 50</p>	<p>1769 VMQ ESPANSO D=0,60 GRIGIO RAL 7035</p>	<p>1770 EPDM NERO SH. 80</p>	<p>1771 EPDM NERO SH. 80</p>	<p>1772 EPDM NERO SH. 80</p>
<p>1773 VMQ ESP. BIANCO D=0,6</p>	<p>1774 VMQ BIANCO SH. 70 RAL 9016</p>	<p>1775 VMQ BIANCO SH. 70 DPAL.</p>	<p>1776 VMQ ROSSO SH. 70</p>	<p>1777 EPDM NERO SH. 70</p>	<p>1778 VMQ NERO ESPANSO D=0,8</p>	<p>1779 VMQ TRASP. SH. 60</p>

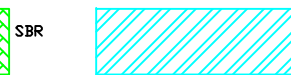
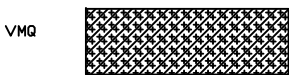
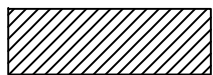

<p>1780 VMQ TRASP. SH. 60</p>	<p>1781 VMQ TRASP. SH. 60</p>	<p>1782 VMQ TRASP. SH. 60</p>	<p>1783 EPDM NERO SH. 90</p>	<p>1784 EPDM NERO SH. 90</p>	<p>1785 VMQ ESP. GRIGIO RAL 7035 D=0,8</p>	<p>1786 VMQ BLU SH. 60 RAL 5015</p>
<p>1787 EPDM NERO SH. 60</p>	<p>1788 EPDM NERO SH. 70</p>	<p>1789 VMQ BIANCO SH. 70 RAL 9016</p>	<p>1790 VMQ ESPANSO GRIGIO D=0,85</p>	<p>1791 VMQ BIANCO SH.50</p>	<p>1792 VMQ BLU SH. 60</p>	<p>1793 VMQ ESPANSO NERO D=0,80</p>
<p>1794 VMQ NERO SH.60</p>	<p>1795 EPDM NERO SH. 70</p>	<p>1796 VMQ PT. TRASP. SH.70</p>	<p>1797 EPDM GRIGIO SH. 80</p>	<p>1798 VMQ BIANCO SH. 70</p>	<p>1799 EPDM NERO SH. 70</p>	<p>1800 VMQ GRIGIO SH. 80 RAL 7040</p>
<p>1801 VMQ GRIGIO SH. 50 RAL 7037</p>	<p>1802 VMQ NERO SH. 60</p>	<p>1803 EPDM NERO SH. 80</p>	<p>1804 EPDM NERO SH. 80</p>	<p>1805 EPDM NERO SH. 80</p>	<p>1806 VMQ NERO SH. 60</p>	<p>1807 VMQ TRASP. SH. 70</p>
<p>1808 VMQ BIANCO SH. 70</p>	<p>1809 VMQ TRASP. SH. 70</p>	<p>1810 EPDM NERO SH. 80</p>	<p>1811 EPDM NERO SH. 70</p>	<p>1812 EPDM NERO SH. 80</p>	<p>1813 VMQ NERO SH. 60</p>	<p>1814 VMQ NERO HT SH.50</p>

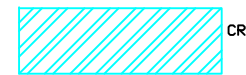
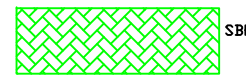
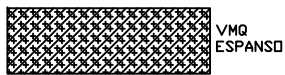

<p>1815 silicone grigio 7037 aliment. FDA sh.60</p>	<p>1816 silicone Alta Resistenza a Laceraz., Rosso o Nero Sh 60</p>	<p>1817 EPDM Nero 80 Sh.A</p>	<p>1818 Silicone Platinico molto trasparente Sh. 70</p>	<p>1819 Silicone espanso nero densità 0,50</p>	<p>1820 Silicone platinico trasparente Sh 70</p>	<p>1821 Silicone grigio alimentare, Sh 60</p>
<p>1822 EPDM Nero, ShA 80</p>	<p>1823 EPDM Nero, ShA 80</p>	<p>1824 EPDM Nero, ShA 80</p>	<p>1825 VMQ ESPANSO GRIGIO D = 0,60</p>	<p>1826 EPDM NERO SH. 55</p>	<p>1827 EPDM NERO SH. 65</p>	<p>1828 EPDM NERO SH 80</p>
<p>1829 VMQ BIANCO SH. 65</p>	<p>1830 VMQ BIANCO SH. 65</p>	<p>1831 EPDM NERO SH. 80</p>	<p>1832 VMQ NERO SH.60</p>	<p>1833 VMQ TRASP. SH. 60</p>	<p>1834 EPDM NERO SH. 70</p>	<p>1835 EPDM FDA NERO SH.60</p>
<p>1836 EPDM NERO SH. 80</p>	<p>1837 EPDM NERO SH. 80</p>	<p>1838 VMQ BIANCO SH. 70 (v. MT 1808)</p>	<p>1839 EPDM NERO SH. 60</p>	<p>1840 VMQ ESPANSO BIANCO D=0,60</p>	<p>1841 EPDM NERO SH. 70</p>	<p>1842 VMQ TRASP. SH. 60</p>
<p>1843 VMQ GRIGIO SH. 60</p>	<p>1844 VMQ ESPANSO BIANCO D=0,60</p>	<p>1845 EPDM FDA NERO SH 60</p>				
VMQ	VMQ ESPANSO	EPDM	EPDM ESPANSO	NBR	SBR	CR